

# **SAS RAID Cards**

**ARC-1212/1222**

(4/8 Ports PCIe to SAS/SATA RAID Controllers )

## **USER'S Manual**

Version: 1.0

Issue Date: April, 2008

## **Copyright and Trademarks**

The information of the products in this manual is subject to change without prior notice and does not represent a commitment on the part of the vendor, who assumes no liability or responsibility for any errors that may appear in this manual. All brands and trademarks are the properties of their respective owners. This manual contains materials protected under International Copyright Conventions. All rights reserved. No part of this manual may be reproduced in any form or by any means, electronic or mechanical, including photocopying, without the written permission of the manufacturer and the author. All inquiries should be addressed to Areca Technology Corporation.

## **FCC STATEMENT**

This equipment has been tested and found to comply with the limits for a Class B digital device, pursuant to part 15 of the FCC Rules. These limits are designed to provide reasonable protection against interference in a residential installation. This equipment generates, uses, and can radiate radio frequency energy and, if not installed and used in accordance with the instructions, may cause harmful interference to radio communications. However, there is no guarantee that interference will not occur in a particular installation.

# Contents

<b>1. Introduction .....</b>	<b>10</b>
1.1 Overview .....	10
1.2 Features .....	12
<b>2. Hardware Installation .....</b>	<b>15</b>
2.1 Before Your Begin Installation .....	15
2.2 Board Layout.....	16
2.3 Installation.....	18
2.4 SAS Cables .....	23
2.4.1 Internal Min SAS 4i to SATA Cable .....	23
2.4.2 Internal Min SAS 4i to 4xSFF-8482 Cable.....	24
2.4.3 Internal Min SAS 4i to Internal Min SAS 4i cable .....	25
2.5 LED Cables.....	25
<b>3. McBIOS RAID Manager .....</b>	<b>31</b>
3.1 Starting the McBIOS RAID Manager .....	31
3.2 McBIOS RAID manager .....	32
3.3 Configuring Raid Sets and Volume Sets .....	33
3.4 Designating Drives as Hot Spares.....	33
3.5 Using Quick Volume /Raid Setup Configuration .....	34
3.6 Using RAID Set/Volume Set Function Method .....	35
3.7 Main Menu .....	37
3.7.1 Quick Volume/RAID Setup .....	38
3.7.2 Raid Set Function .....	42
3.7.2.1 Create Raid Set .....	43
3.7.2.2 Delete Raid Set .....	44
3.7.2.3 Expand Raid Set.....	45
• Migrating .....	46
3.7.2.4 Activate Incomplete Raid Set.....	46
3.7.2.5 Create Hot Spare.....	47
3.7.2.6 Delete Hot Spare .....	47
3.7.2.7 Raid Set Information .....	48
3.7.3 Volume Set Function .....	48
3.7.3.1 Create Volume Set (0/1/10/3/5/6) .....	50
• Volume Name .....	51
• Raid Level .....	52
• Capacity .....	52
• Stripe Size .....	53
• SCSI Channel .....	54

• SCSI ID .....	54
• SCSI LUN.....	55
• Cache Mode .....	55
• Tag Queuing .....	56
3.7.3.2 Create Raid30/50/60 (Volume Set 30/50/60) .....	56
3.7.3.3 Delete Volume Set .....	57
3.7.3.4 Modify Volume Set.....	58
3.7.3.4.1 Volume Growth.....	59
3.7.3.4.2 Volume Set Migration .....	59
3.7.3.5 Check Volume Set.....	60
3.7.3.6 Stop Volume Set Check .....	61
3.7.3.7 Display Volume Set Info. ....	61
3.7.4 Physical Drives.....	61
3.7.4.1 View Drive Information .....	62
3.7.4.2 Create Pass-Through Disk .....	62
3.7.4.3 Modify a Pass-Through Disk.....	63
3.7.4.4 Delete Pass-Through Disk .....	63
3.7.4.5 Identify Selected Drive .....	64
3.7.5 Raid System Function .....	64
3.7.5.1 Mute The Alert Beeper .....	65
3.7.5.2 Alert Beeper Setting.....	65
3.7.5.3 Change Password .....	66
3.7.5.4 JBOD/RAID Function .....	67
3.7.5.5 Background Task Priority .....	67
3.7.5.6 SATA NCQ Support.....	68
3.7.5.7 HDD Read Ahead Cache.....	69
3.7.5.8 Stagger Power On.....	69
3.7.5.9 Controller Fan Detection .....	70
3.7.5.10 Auto Activate Raid Set.....	71
3.7.5.11 Capacity Truncation.....	71
3.7.6 Ethernet Configuration .....	72
3.7.6.1 DHCP Function .....	72
3.7.6.2 Local IP address .....	73
3.7.6.3 HTTP Port Number .....	74
3.7.6.4 Telnet Port Number .....	75
3.7.6.5 SMTP Port Number.....	75
3.7.6.6 Ethernet Address.....	76
3.7.7 View System Events .....	76
3.7.8 Clear Events Buffer.....	77
3.7.9 Hardware Monitor.....	77
3.7.10 System Information .....	78

<b>4. Driver Installation .....</b>	<b>79</b>
4.1 Creating the Driver Diskettes .....	79
4.2 Driver Installation for Windows .....	81
4.2.1 New Storage Device Drivers in Windows 2003/XP-64/Vista .	81
4.2.2 Install Windows 2000/XP/2003/Vista on a SAS/SATA RAID	
Volume .....	81
4.2.2.1 Installation Procedures .....	81
4.2.2.2 Making Volume Sets Available to Windows System .....	83
4.2.3 Installing controller into an existing Windows 2000/	
XP/2003/Vista Installation .....	83
4.2.3.1 Making Volume Sets Available to Windows System .....	85
4.2.4 Uninstall controller from Windows 2000/XP/2003/Vista....	85
4.3 Driver Installation for Linux .....	86
4.4 Driver Installation for FreeBSD.....	87
4.5 Driver Installation for Solaris .....	87
4.6 Driver Installation for Mac X .....	87
<b>5. ArchHttp Proxy Server Installation.....</b>	<b>89</b>
5.1 For Windows.....	90
5.2 For Linux .....	91
5.3 For FreeBSD.....	93
5.4 For Solaris 10 X86.....	93
5.5 For Mac OS 10.X.....	93
<b>6. Web Browser-based Configuration .....</b>	<b>98</b>
6.1 Start-up McRAID Storage Manager .....	98
• Start-up McRAID Storage Manager from Windows Local	
Administration.....	99
6.2 SAS RAID controller McRAID Storage Manager .....	101
6.3 Main Menu .....	102
6.4 Quick Function.....	102
6.5 Raid Set Functions .....	103
6.5.1 Create Raid Set .....	103
6.5.2 Delete Raid Set .....	104
6.5.3 Expand Raid Set.....	104
6.5.4 Activate Incomplete Raid Set .....	105
6.5.5 Create Hot Spare .....	106
6.5.6 Delete Hot Spare.....	106
6.5.7 Rescue Raid Set .....	107
6.5.8 Offline Raid Set.....	107
6.6 Volume Set Functions .....	107
6.6.1 Create Volume Set (0/1/10/3/5/6) .....	108

• Volume Name .....	109
• Volume Raid Level .....	109
• Capacity .....	109
• Greater Two TB Volume Support.....	109
• Initialization Mode .....	109
• Strip Size.....	110
• Cache Mode .....	110
• Tagged Command Queuing .....	110
6.6.2 Create Raid30/50/60 (Volume Set 30/50/60) .....	111
6.6.3 Delete Volume Set.....	111
6.6.4 Modify Volume Set.....	112
6.6.4.1 Volume Growth .....	113
6.6.4.2 Volume Set Migration .....	113
6.6.5 Check Volume Set .....	114
6.6.6 Stop Volume Set Check.....	115
6.7 Physical Drive .....	115
6.7.1 Create Pass-Through Disk.....	115
6.7.2 Modify Pass-Through Disk.....	116
6.7.3 Delete Pass-Through Disk.....	117
6.7.4 Identify Drive .....	117
6.8 System Controls .....	118
6.8.1 System Config .....	118
• System Beeper Setting .....	118
• Background Task Priority .....	118
• JBOD/RAID Configuration .....	118
• HDD Read Ahead Cache .....	119
• HDD Queue Depth .....	119
• Stagger Power on .....	119
• Auto Activate Incomplete Raid .....	119
• Disk Capacity Truncation Mode.....	120
6.8.2 Ethernet Configuration .....	120
6.8.3 Alert By Mail Configuration .....	121
6.8.4 SNMP Configuration .....	122
6.8.5 NTP Configuration .....	123
• NTP Sever Address.....	123
• Time Zone.....	124
• Automatic Daylight Saving.....	124
6.8.6 View Events/Mute Beeper .....	124
6.8.7 Generate Test Event .....	125
6.8.8 Clear Events Buffer.....	125
6.8.9 Modify Password .....	125
6.8.10 Update Firmware .....	126

6.9 Information .....	127
6.9.1 Raid Set Hierarchy .....	127
6.9.2 System Information .....	127
6.9.3 Hardware Monitor .....	128
<b>Appendix A .....</b>	<b>129</b>
Upgrading Flash ROM Update Process .....	129
Upgrading Firmware Through McRAID Storage Manager .....	130
Upgrading Firmware Through nflash DOS Utility .....	131
Upgrading Firmware Through CLI .....	132
<b>Appendix B .....</b>	<b>134</b>
Battery Backup Module (ARC-6120-BAT-Txx) .....	134
BBM Components .....	134
Status of BBM .....	134
Installation .....	134
Battery Backup Capacity .....	135
Operation .....	135
Changing the Battery Backup Module .....	136
BBM Specifications .....	136
<b>Appendix C .....</b>	<b>138</b>
SNMP Operation & Installation .....	138
<b>Appendix D .....</b>	<b>145</b>
Event Notification Configurations .....	145
A. Device Event .....	145
B. Volume Event .....	146
C. RAID Set Event .....	147
D. Hardware Monitor Event .....	147
<b>Appendix E .....</b>	<b>149</b>
RAID Concept .....	149
RAID Set .....	149
Volume Set .....	149
Ease of Use Features .....	150
• Foreground Availability/Background Initialization .....	150
• Online Array Roaming .....	150
• Online Capacity Expansion .....	150
• Online Volume Expansion .....	153
High availability .....	153
• Global Hot Spares .....	153
• Hot-Swap Disk Drive Support .....	154
• Auto Declare Hot-Spare .....	154
• Auto Rebuilding .....	155
• Adjustable Rebuild Priority .....	155

High Reliability .....	156
• Hard Drive Failure Prediction.....	156
• Auto Reassign Sector.....	156
• Consistency Check .....	157
Data Protection .....	157
• Battery Backup .....	157
• Recovery ROM .....	158
<b>Appendix F .....</b>	<b>159</b>
Understanding RAID .....	159
RAID 0 .....	159
RAID 1 .....	160
RAID 3 .....	161
RAID 5 .....	162
RAID 6 .....	163
RAID x0 .....	163
JBOD .....	164
Single Disk (Pass-Through Disk) .....	164



# INTRODUCTION

---

## 1. Introduction

This section presents a brief overview of the SAS RAID controller, ARC-1212/1222 series. (PCIe to SAS/SATA RAID controllers)

### 1.1 Overview

SAS builds on parallel SCSI by providing higher performance, improving data availability, and simplifying system design. The SAS interface supports both SAS disk drives for data-intensive applications and Serial ATA (SATA) drives for low-cost bulk storage of reference data. The ARC-1212/1222 support directly attach 4/8 SAS ports via one internal /two internal Min SAS connector. Each port on the SAS controllers supports SAS and/or SATA devices. Since there is no expander support on those boards, this can meet the customer inquiry SAS solution (using same enclosure) to replace SATA solution. The ARC-1212/1222 RAID controllers only support directly attach to 4/8 SAS/SATA drives without supporting the expand function.

The ARC-1212/1222 RAID controllers are low-profile PCIe cards, ideal for 1U and 2U rack-mount systems without needing the expansion capability. These controllers utilize the same RAID kernel that has been field-proven in existing external RAID controller products, allowing Areca to quickly bring stable and reliable RAID controllers to the market

### Unparalleled Performance

The SAS RAID controllers raise the standard to higher performance levels with several enhancements including Intel new high-performance I/O Processor, a DDR2-533 memory architecture and high performance PCIe x8 Link host interface bus interconnection. The low profile controllers by default support on-board 256MB of ECC DDR2-533 SDRAM memory with optional battery backup module. The test result is against overall performance compared to other SAS RAID controllers. The powerful Intel new I/O processors integrated 4/8-port SAS I/O ports on chip delivers high performance for servers and workstations.

# INTRODUCTION

---

## **Unsurpassed Data Availability**

As storage capacities continue to rapidly increase, users need greater level of disk drive fault tolerance, which can be implemented without doubling the investment in disk drives. The RAID 6 can offer fault tolerance greater than RAID 1 or RAID 5 but only consumes the capacity of 2 disk drives for distributed parity data. The SAS RAID controllers with extreme performance RAID 6 engine installed provide the highest RAID 6 feature to meet this requirement. The controller can concurrently compute two parity blocks and get very similar RAID 5 performance.

The SAS RAID controllers can also provide RAID levels 0, 1, 10, 3, 5, 6, 30, 50, 60, Single Disk or JBOD for maximum configuration flexibility. Its high data availability and protection derives from the following capabilities: Online RAID Capacity Expansion, Array Roaming, Online RAID Level / Stripe Size Migration, Global Online Spare, Automatic Drive Failure Detection, Automatic Failed Drive Rebuilding, Disk Hot-Swap, Online Background Rebuilding, Instant Availability/Background Initialization, Auto Reassign Sector, Redundant Flash Image and Battery Backup Module. Greater than Two TB Support allows for very large volume set application in 64-bit environment such as data-mining and managing large databases.

## **Maximum Interoperability**

The SAS RAID controller support broad operating system including Windows Vista/Server 2003/XP/2000, Linux (Open Source), FreeBSD (Open Source), Solaris (Open Source), Mac and more, along with key system monitoring features such as enclosure management (SGPIO) and SNMP function. Our products and technology are based on extensive testing and validation process; leverage Areca SATA RAID controller field-proven compatibility with operating systems, motherboards, applications and device drivers.

# INTRODUCTION

---

## Easy RAID Management

The controllers contain an embedded McBIOS RAID manager that can access via hot key at M/B BIOS boot-up screen. This pre-boot McBIOS RAID manager can use to simplify the setup and management of RAID controller. The controller firmware also contains a browser-based McRAID storage manager which can be accessed through the Ethernet port or ArchHttp proxy server in Windows, Linux, FreeBSD and more environments. The McRAID storage manager allows local and remote to create and modify RAID set, volume set, and monitor RAID status from standard web browser. The Single Admin Portal (SAP) monitor utility can support one application to scan multiple RAID units in the network. The Disk Stress Test (DST) utility kicks out disks meeting marginal spec before the RAID unit is actually put on-line for real business.

## 1.2 Features

### **Adapter Architecture**

- Intel 800MHz IOP348 I/O processor with SAS controller
- PCIe x8 Link host interface
- 256MB on-board DDR2-533 SDRAM with ECC
- Write-through or write-back cache support
- ARC-1212 supports up to 4 internal SAS/SATA II HDDs.
- ARC-1222 supports up to 8 internal SAS/SATA II HDDs.
- Multi-adapter support for large storage requirements
- BIOS boot support for greater fault tolerance
- BIOS PnP (plug and play) and BBS (BIOS boot specification) support
- Intel RAID engine support extreme performance RAID 6 function
- NVRAM for RAID configuration & transaction log
- Redundant flash image for adapter availability
- Battery Backup Module (BBM) ready (Option)
- RoHS Compliant

### **RAID Features**

- RAID level 0, 1, 10, 3, 5, 6, 30, 50, 60, Single Disk or JBOD
- Multiple RAID selection

# INTRODUCTION

---

- Online array roaming
- Online RAID level/stripe size migration
- Online capacity expansion and RAID level migration simultaneously
- Online volume set growth
- Instant availability and background initialization
- Automatic drive insertion/removal detection and rebuilding
- Greater than 2TB per volume set (64-bit LBA support)
- Support spin down drives when not in use to extend service life (MAID)
- Support NTP protocol synchronize RAID controller clock over the on board Ethernet port

## **Monitors/Notification**

- System status indication through global HDD activity/fault connector, individual activity/fault connector, LCD/I2C connector and alarm buzzer
- SMTP support for email notification
- SNMP support for remote manager
- Enclosure management (Serial Bus and SGPIO) ready

## **RAID Management**

- Field-upgradeable firmware in flash ROM

## **In-Band Manager**

- Hot key "boot-up" McBIOS RAID manager via M/B BIOS
- Web browser-based McRAID storage manager via ArchHttp proxy server for all operating systems
- Support Command Line Interface (CLI)
- API library for customer to write monitor utility
- Single Admin Portal (SAP) monitor utility
- Disk Stress Test (DST) utility for production

## **Out-of-Band Manager**

- Firmware-embedded web browser-based McRAID storage manager, SMTP manager, SNMP agent and Telnet function via Ethernet port
- API library for customer to write monitor utility
- Support Push Button and LCD display panel (option)

# INTRODUCTION

**Operating System** (Same as Areca SATA II RAID adapter field-proven device drivers)

- Windows 2000/XP/server 2003/Vista
- Linux
- FreeBSD
- Novell Netware 6.5
- Solaris 10 x86/x86\_64
- SCO UnixWare 7.1.4
- Mac OS X 10.x (EFI BIOS support)

(For latest supported OS listing visit <http://www.areca.com.tw>)

SAS RAID card		
<b>Model name</b>	ARC-1212	ARC-1222
<b>I/O Processor</b>	Intel IOP348 800MHz	
<b>Form Factor</b>	Low Profile: 62(H) x 168(L) mm	
<b>Host Bus Type</b>	PCIe x8 Lanes	
<b>Driver Connector</b>	1 x SFF-8087	2 x SFF-8087
<b>Drive Support</b>	4 x SAS/SATA	8 x SAS/SATA
<b>RAID Level</b>	0, 1, 10, 3, 5, 6, Single Disk or JBOD	0, 1, 10, 3, 5, 6, 30, 50, 60, Single Disk or JBOD
<b>On-Board Cache</b>	DDR2-533 256MB	DDR2-533 256MB
<b>Management Port</b>	In-Band: PCIe Out-of-Band: BIOS, LCD and LAN Port	
<b>Enclosure Ready</b>	Individual Activity/Faulty Header, Serial Bus and SGPIO	

## 2. Hardware Installation

This section describes the procedures for installing the SAS RAID controllers.

### 2.1 Before Your Begin Installation

Thanks for purchasing the SAS RAID controller as your RAID data storage subsystem. This user manual gives simple step-by-step instructions for installing and configuring the SAS RAID controller. To ensure personal safety and to protect your equipment and data, reading the following information package list carefully before you begin installing.

#### Package Contents

If your package is missing any of the items listed below, contact your local dealers before you install. (**Disk drives and disk mounting brackets are not included**)

- 1 x SAS RAID controller in an ESD-protective bag
- 1 x Installation CD – containing driver, relative software, an electronic version of this manual and other related manual
- 1 x User Manual

# HARDWARE INSTALLATION

## 2.2 Board Layout

The controller can support a family included 4/8 ports models with 1/2 internal SFF-8087 connectors. This section provides the board layout and connector/jumper for the SAS RAID controller.

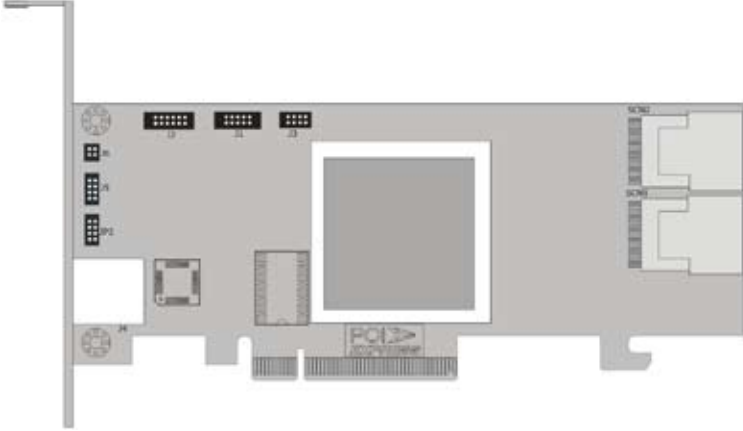

Figure 2-1, ARC-1212/1222 SAS RAID Controller

Connector	Type	Description
1. (J4)	Ethernet Port	RJ45
2. (JP2)	Individual Fault LED Header	8-pin header
3. (J5)	Individual Activity (HDD) LED Header	8-pin header
4. (J6)	Global Fault/Activity-Cache Write Pending LED	4-pin header
5. (J2)	Battery Backup Module Connector	12-pin box header
6. (J1)	Manufacture Purpose Port	10-pin header
7. (J3)	I2C/LCD Connector	8-pin header
8. (SCN1)	SAS 1-4 Ports for ARC-1212/1222	Min SAS 4i
9. (SCN2)	SAS 5-8 Ports for ARC-1222	Min SAS 4i

Table 2-1 , ARC-1212/1222 Connector

# HARDWARE INSTALLATION

---

## Tools Required

An ESD grounding strap or mat is required. Also required are standard hand tools to open your system's case.

## System Requirement

The SAS RAID controller can be installed in a universal PCIe slot and requires a motherboard that:

ARC-1212/1222 series SAS RAID controller requires:

- Comply with the PCIe x8  
It can work on the PCIe x1, x4, x8, and x16 signal with x8 or x16 slot M/B.

## Installation Tools

The following items may be needed to assist with installing the SAS RAID controller into an available PCIe expansion slot.

- Small screwdriver
- Host system hardware manuals and manuals for the disk or enclosure being installed.

## Personal Safety Instructions

Use the following safety instructions to help you protect your computer system from potential damage and to ensure your own personal safety.

- Always wear a grounding strap or work on an ESD-protective mat.
- Before opening the system cover, turn off power switches and unplug the power cords. Do not reconnect the power cords until you have replaced the covers.

# HARDWARE INSTALLATION

---

## **Warning:**

High voltages may be found inside computer equipment. Before installing any of the hardware in this package or removing the protective covers of any computer equipment, turn off power switches and disconnect power cords. Do not reconnect the power cords until you have replaced the covers.

## **Electrostatic Discharge**

Static electricity can cause serious damage to the electronic components on this SAS RAID controller. To avoid damage caused by electrostatic discharge, observe the following precautions:

- Do not remove the SAS RAID controller from its anti-static packaging until you are ready to install it into a computer case.
- Handle the SAS RAID controller by its edges or by the metal mounting brackets at its each end.
- Before you handle the SAS RAID controller in any way, touch a grounded, anti-static surface, such as an unpainted portion of the system chassis, for a few seconds to discharge any built-up static electricity.

## **2.3 Installation**

Use the following instructions below to install a PCIe SAS RAID controller.

### **Step 1. Unpack**

Unpack and remove the PCIe SAS RAID controller from the package. Inspect it carefully, if anything is missing or damaged, contact your local dealer.

### **Step 2. Power PC/Server Off**

Turn off computer and remove the AC power cord. Remove the system's cover. For the instructions, please see the computer system documentation.

# HARDWARE INSTALLATION

## Step 3. Install the PCIe SAS RAID Cards

To install the SAS RAID controller, remove the mounting screw and existing bracket from the rear panel behind the selected PCIe slot. Align the gold-fingered edge on the card with the selected PCIe slot. Press down gently but firmly to ensure that the card is properly seated in the slot, as shown in Figure 2-6. Then, screw the bracket into the computer chassis. ARC-1212/1222 series cards require a PCIe x8 slot.

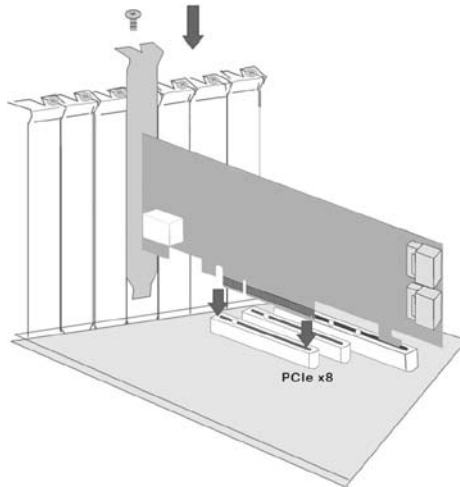

Figure 2-2, Insert SAS RAID controller into a PCIe slot

## Step 4. Mount the Drives

You can connect the SAS/SATA drives to the controller through direct cable and backplane solutions. In the direct connection, SAS/SATA drives are directly connected to SAS RAID controller PHY port with SAS/SATA cables. The SAS RAID controller can support up to 4/8 PHY ports. Remove the front bezel from the computer chassis and install the cages or SAS/SATA drives in the computer chassis. Loading drives to the drive tray if cages are installed. Be sure that the power is connected to either the cage backplane or the individual drives.

# HARDWARE INSTALLATION

In the backplane solution, SAS/SATA drives are directly connected to SAS/SATA system backplane. The number of SAS/SATA drives is limited to the number of slots available on the backplane.

## Step 5. Install SAS Cable

This section describes SAS cable how to connect on controller.

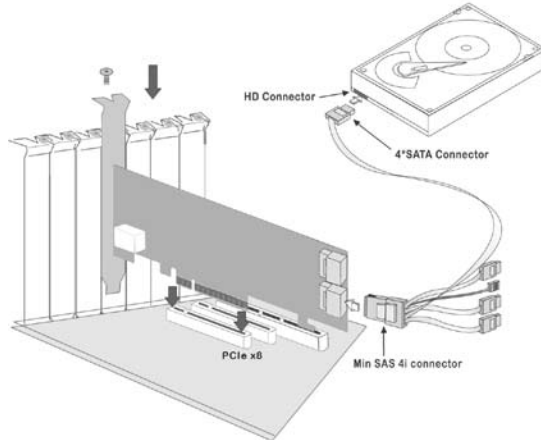

Figure 2-3, SAS Cable Connect to HD

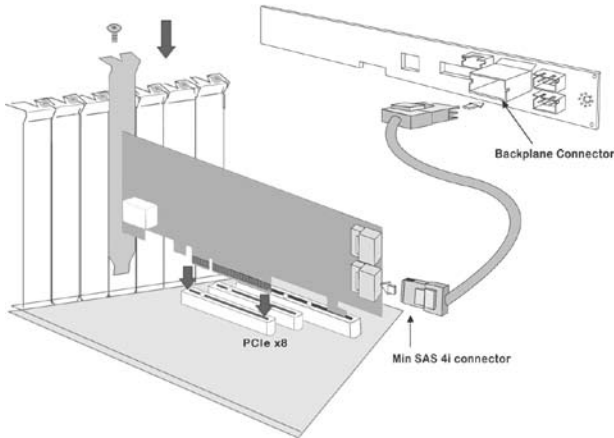

Figure 2-4, SAS Cable Connect to Backplane

# HARDWARE INSTALLATION

---

## Step 6. Install the LED Cable (option)

The preferred I/O connector for server backplanes is the Min SAS 4i internal connector. This connector has eight signal pins to support four SAS/SATA drives and six pins for the SGPIO (Serial General Purpose Input/Output) side-band signals. The SGPIO bus is used for efficient LED management and for sensing drive Locate status. See SFF 8485 for the specification of the SGPIO bus. For backplane without SGPIO supporting, Please refer to Section 2.4 LED cables for Fault/Activity LED cable installation.

**LED Management:** The backplane may contain LEDs to indicate drive status. Light from the LEDs could be transmitted to the outside of the server by using light pipes mounted on the SAS drive tray. A small microcontroller on the backplane, connected via the SGPIO bus to a SAS RAID controller, could control the LEDs. Activity: blinking 5 times/second and Fault: solid illuminated

**Drive Locate Circuitry:** The location of a drive may be detected by sensing the voltage level of one of the pre-charge pins before and after a drive is installed.

The following signals define the SGPIO assignments for the Min SAS 4i internal connector (SFF-8087) in the SAS RAID controller.

PIN	Description	PIN	Description
SideBand0	SClock (Clock signal)	SideBand1	SLoad (Last clock of a bit stream)
SideBand2	Ground	SideBand3	Ground
SideBand4	SDataOut (Serial data output bit stream)	SideBand5	SDataIn (Serial data input bit stream)
SideBand6	Reserved	SideBand7	Reserved

## Step 7. Adding a Battery Backup Module (optional)

Please refer to Appendix B for installing the BBM in your SAS RAID controller.

# HARDWARE INSTALLATION

---

## **Step 8. Re-check Fault LED Cable Connections (optional)**

Be sure that the proper failed drive channel information is displayed by the Fault LEDs. An improper connection will tell the user to “Hot Swap” the wrong drive. This can result in removing the wrong disk (one that is functioning properly) from the controller. This can result in failure and loss of system data.

## **Step 9. Power up the System**

After check the installation, reinstall the computer cover, and reconnect the power cord cables. Turn on the power switch at the rear of the computer (if equipped) and then press the power button at the front of the host computer.

## **Step 10. Configure Volume Set**

The controller configures RAID functionality through the McBIOS RAID manager. Please refer to Chapter 3, McBIOS RAID Manager, for the detail. The RAID controller can also be configured through the McRAID storage manager with ArcHttp proxy server installed, LCD module (refer to LCD manual) or through on-board LAN port. For this option, please refer to Chapter 6, Web Browser-Based Configuration.

## **Step 11. Install the Controller Driver**

### For a new system:

- Driver installation usually takes places as part of operating system installation. Please refer to Chapter 4 Diver Installation for the detailed installation procedure.

### In an existing system:

- To install the controller driver into the existing operating system. For the detailed installation procedure, please refer to the Chapter 4, Driver Installation.

### **Note:**

For lastest release versions of drivers, please download from <http://www.areca.com.tw>

# HARDWARE INSTALLATION

---

## Step 12. Install ArcHttp Proxy Server

The SAS RAID controller firmware has embedded the web-browser McRAID storage manager. ArcHttp proxy server will launch the web-browser McRAID storage manager. It provides all of the creation, management and monitor SAS RAID controller status. Please refer to the Chapter 5 for the detail ArcHttp Proxy Server Installation. For SNMP agent function, please refer to Appendix C.

## Step 13. Determining the Boot Sequences

The SAS RAID controller is a bootable controller. If your system already contains a bootable device with an installed operating system, you can set up your system to boot a second operating system from the new controller. To add a second bootable controller, you may need to enter setup of motherboard BIOS and change the device boot sequence so that the SAS RAID controller heads the list. If the system BIOS setup does not allow this change, your system may not be configurable to allow the SAS RAID controller to act as a second boot device.

## 2.4 SAS Cables

You can connect the end devices to each other through direct cables or through the SAS expander/backplane connections. The SAS RAID controller supports daisy-chain expansion up to 8 enclosures. The following is an example of some internal SAS/SATA cables and an external SAS cable.

### 2.4.1 Internal Min SAS 4i to SATA Cable

The Min SAS 4i to SATA cables are used for connection between the SAS RAID controller internal connectors and connectors on the SAS/SATA disk drives or SAS/SATA connector backplane. The SAS controllers has 1-2 Min SAS 4i (SFF-8087) internal connectors, each of them can support up to four SAS/SATA drives.

These adapters can be installed in a server RAID enclosure with standard SATA connectors backplane. The following diagram shows the picture of Min SAS 4i to 4 x SATA cables. Backplane

# HARDWARE INSTALLATION

---

supports SGPIO header can leverage the SGPIO function on the SAS RAID controller through the sideband cable.

The sideband cable is reserved for the backplane with header on it.

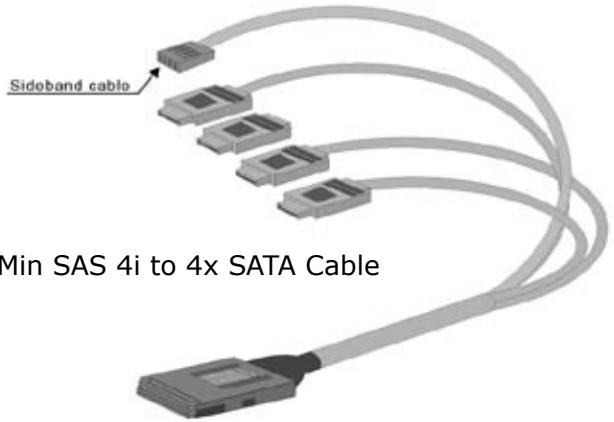

Figure 2-5, Internal Min SAS 4i to 4x SATA Cable

## 2.4.2 Internal Min SAS 4i to 4xSFF-8482 Cable

These controllers can be installed in a server RAID enclosure with out a backplane. The kind of cable will attach directly to the SAS disk drives. The following diagram shows the picture of Min SAS 4i to 4xSFF-8482 cables.

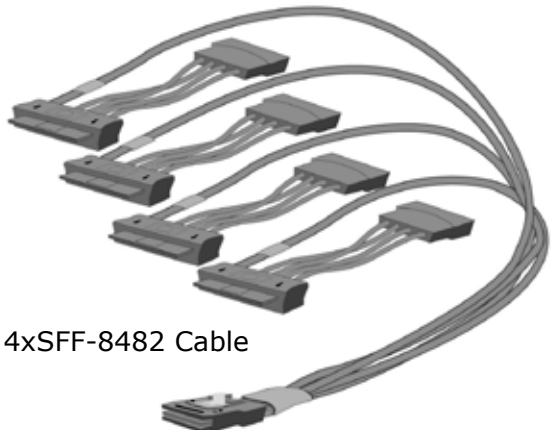

Figure 2-6, Min SAS 4i to 4xSFF-8482 Cable

# HARDWARE INSTALLATION

---

## 2.4.3 Internal Min SAS 4i to Internal Min SAS 4i cable

The SAS RAID controllers have 1-6 Min SAS 4i internal connectors, each of them can support up to four SAS/SATA signals. These adapters can be installed in a server RAID enclosure with Min SAS 4i internal connectors backplane. This Min SAS 4i cable has eight signal pins to support four SAS/SATA drives and six pins for the SGPIO (Serial General Purpose Input/ Output) side-band signals. The SGPIO bus is used for efficient LED management and for sensing drive Locate status.



Figure 2-7, Min SAS 4i to Min SAS 4i Cable

## 2.5 LED Cables

There is no SGPIO supported in the most of old version SATA backplane. The SAS controller also provides two kinds of alternative LED cable header to support the fault/activity status for those backplanes. The Global Indicator Connector is used by the server global indicator LED.

The following electronics schematic is the SAS RAID controller logical of fault/activity header. The signal for each pin is cathode (-) side.

# HARDWARE INSTALLATION

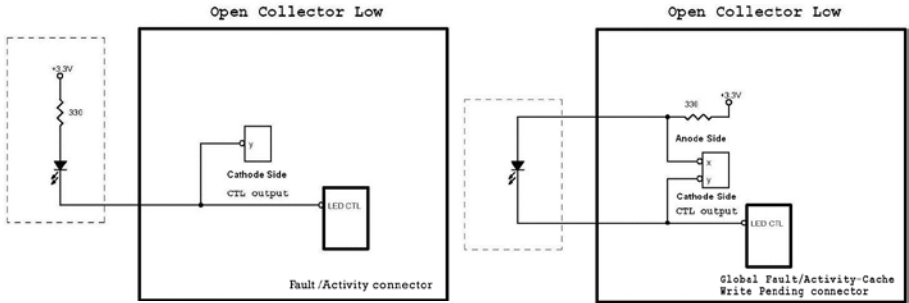

**Note:**

A cable for the global indicator comes with your computer system. Cables for the individual drive LEDs may come with a drive cage, or you may need to purchase them.

The following diagrams and descriptions describe each type of connector.

**A: Individual Fault LED Indicator Connector**

Most of the backplane has supported the HDD activity from the HDD. The SAS RAID controller also provides the fault activity for fault LED. Connect the cables for the drive fault LEDs between the backplane of the cage and the respective connector on the SAS RAID controller. The following table is the fault LED signal behavior.

LED	Normal Status	Problem Indication
Fault LED	When the fault LED is solid illuminated, there is no disk present. When the fault LED is off, then disk is present and status is normal.	When the fault LED is slow blinking (2 times/sec), that disk drive has failed and should be hot-swapped immediately. When the activity LED is illuminated and fault LED is fast blinking (10 times/sec) there is rebuilding activity on that disk drive.

# HARDWARE INSTALLATION

Figure 2-8, ARC-1212/1222 Individual LED Indicators connector, for each channel drive.

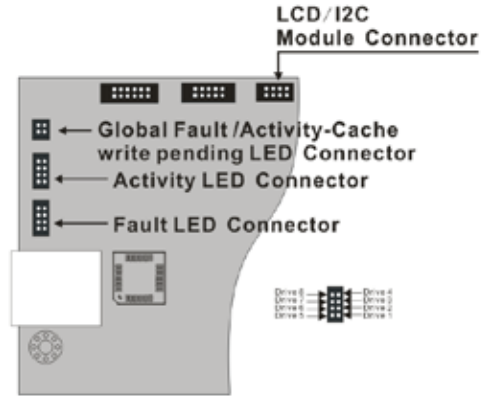

## B: I<sup>2</sup>C Connector

You can also connect the I<sup>2</sup>C interface to a proprietary SAS/SATA backplane enclosure. This can reduce the number of activity LED and/or fault LED cables. The I<sup>2</sup>C interface can also cascade to another SAS/SATA backplane enclosure for the additional channel status display.

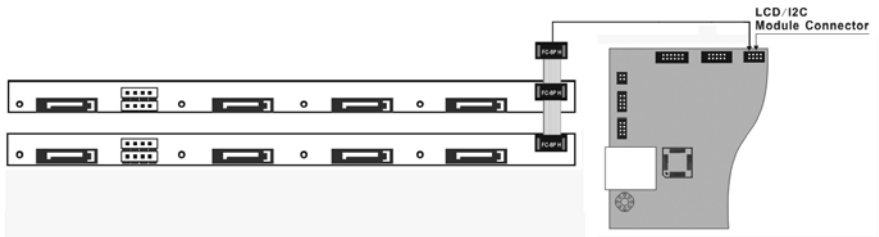
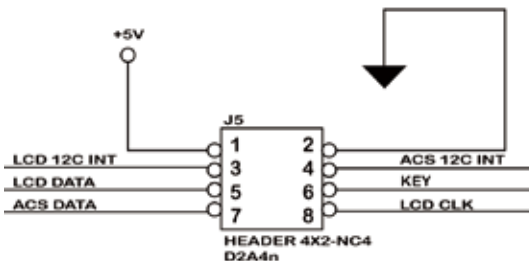

Figure 2-15, Activity/Fault LED I<sup>2</sup>C connector connected between SAS RAID Controller & 4 SATA HDD backplane.

The following picture and table is the I<sup>2</sup>C signal name description for LCD & fault/activity LED.



# HARDWARE INSTALLATION

PIN	Description	PIN	Description
1	Power (+5V)	2	GND
3	LCD Module Interrupt	4	Protect Key
5	LCD Module Serial Data	6	Fault/Activity Clock
7	Fault/Activity Serial Data	8	LCD Module Clock

## C: Global Indicator Connector

If the system will use only a single global activity/fault indicator, attach the LED to the two pins global activity and two pins global fault connector. The global fault pin pair connector is the overall fault signals. The global activity pin pair connector is the overall activity signals.

The following diagrams show the connector and pin locations.

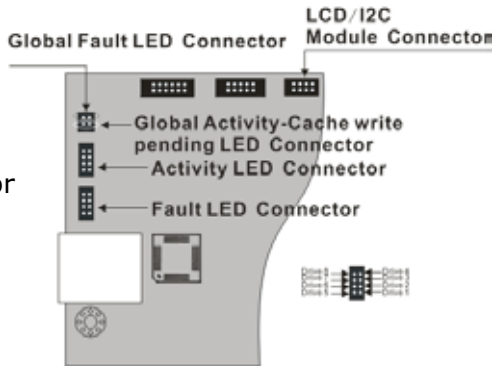

Figure 2-9, ARC-1212/1222  
Global Indicator Connector for  
Computer Case.

## 2.6 Summary of the installation

The flow chart below describes the installation procedures for SAS RAID controllers. These procedures includes hardware installation, the creation and configuration of a RAID volume through the Mc-BIOS/McRAID, OS installation and installation of SAS RAID controller software.

The software components configure and monitor the SAS RAID controllers as following table.

# HARDWARE INSTALLATION

Configuration Utility	Operating System Supported
McBIOS RAID Manager	OS-Independent
McRAID Storage Manager (Via Archttp proxy server)	Windows 2000/XP/Server 2003/Vista, Linux, FreeBSD, Solaris and Mac
SAP Monitor (Single Admin Portal to scan for multiple RAID units in the net- work, via Archttp proxy server)	Windows 2000/XP/Server 2003/Vista
SNMP Manager Console Integration	Windows 2000/XP/Server 2003/Vista

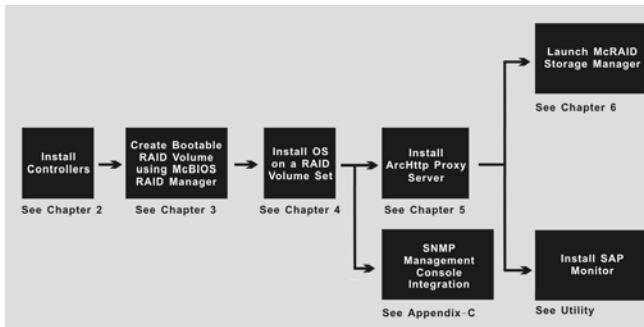

## McRAID Storage Manager

Before launching the firmware-embedded web server, McRAID storage manager through the PCIe bus, you need first to install the Archttp proxy server on your server system. If you need additional information about installation and start-up of this function, see the McRAID Storage Manager section in Chapter 6.

## SNMP Manager Console Integration

### ● Out of Band-Using LAN Port

Before launching the controller's firmware-embedded SNMP agent, you need first to enable the firmware-embedded SNMP agent function and install the SNMP extension agent software on your server system. If you need additional information about installation and start-up this function, see the section 6.9.4 SNMP Configuration.

# HARDWARE INSTALLATION

---

- **In-Band-Using PCIe Bus**

Before launching the SNMP agent in the sever, you need first to enable the firmware-embedded SNMP community configuration and install Areca SNMP extension agent in your server system. If you need additional information about installation and start-up the function, see the SNMP Operation & Installation section in the Appendix C.

## **Single Admin Portal (SAP) Monitor**

This utility can scan for multiple RAID units on the network and monitor the controller set status. It also includes a Disk Stress Test (DST) utility to identify marginal spec disks before the RAID unit is put into a production environment.

For additional information, see the utility manual (SAP) in the software packaged CD or download it from the web site **<http://www.areca.com.tw>**

# BIOS CONFIGURATION

## 3. McBIOS RAID Manager

The system mainboard BIOS automatically configures the following SAS RAID controller parameters at power-up:

- I/O Port Address
- Interrupt Channel (IRQ)
- Adapter ROM Base Address

Use McBIOS RAID manager to further configure the SAS RAID controller to suit your server hardware and operating system.

### 3.1 Starting the McBIOS RAID Manager

This section explains how to use the McBIOS RAID manager to configure your RAID system. The McBIOS RAID manager is designed to be user-friendly. It is a menu-driven program, residing in the firmware, which allows you to scroll through various menus and sub-menus and select among the predetermined configuration options.

When starting a system with a SAS RAID controller installed, it will display the following message on the monitor during the start-up sequence (after the system BIOS startup screen but before the operating system boots):

```
ARC-1212 PCIe4 RAID Controller - DRAM: 256(MB) / #Channels: 16
BIOS: V1.17b / Date: 2006-8-07 - F/W: V1.42 / Date: 2007-3-1
▶ Bus/Dev/Fun= 1/0/0, I/O-Port=28000000h, IRQ=9, BIOS=CB00 : 0h
▶▶ No BIOS disk found. RAID controller BIOS not installed!
▶▶▶ Press <Tab/F6> to enter SETUP menu. 9 second(s) left <ESC> to Skip>..
```

The McBIOS RAID manager message remains on your screen for about nine seconds, giving you time to start the configuration menu by pressing **Tab** or **F6**. If you do not wish to enter configuration menu, press **ESC** to skip configuration immediately. When activated, the McBIOS RAID manager window appears showing a selection dialog box listing the SAS RAID controllers that are installed in the system.

The legend at the bottom of the screen shows you what keys are enabled for the windows.

# BIOS CONFIGURATION

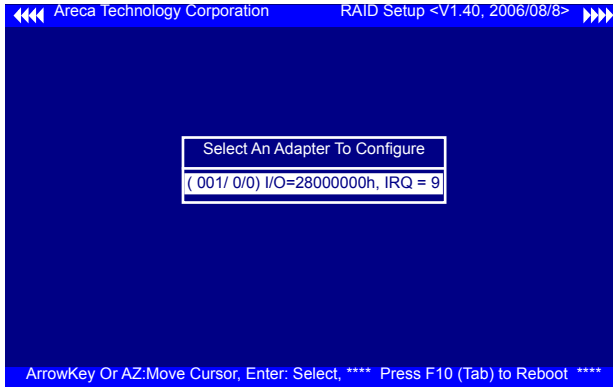

Use the **Up** and **Down** arrow keys to select the controller you want to configure. While the desired controller is highlighted, press the **Enter** key to enter the main menu of the McBIOS RAID manager.

I/O Port Addr : 28000000h, F2(Tab): Select Controller, F10: Reboot System

Areca Technology Corporation RAID Controller

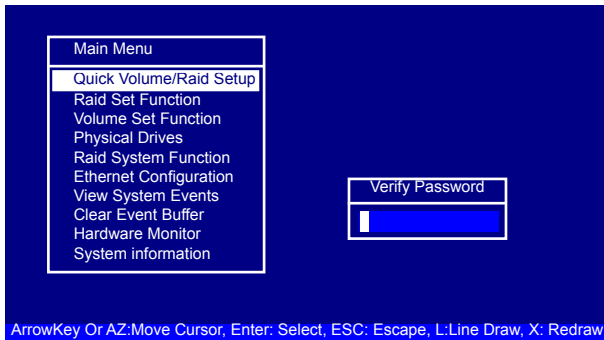

**Note:**

The manufacture default password is set to **0000**; this password can be modified by selecting **Change Password** in the **Raid System Function** section.

## 3.2 McBIOS RAID manager

The McBIOS RAID manager is firmware-based and is used to configure RAID sets and volume sets. Because the utility resides in the SAS RAID controller firmware, operation is independent of any operating systems on your computer. This utility can be used to:

- Create RAID sets,
- Expand RAID sets,
- Add physical drives,

# BIOS CONFIGURATION

---

- Define volume sets,
- Modify volume sets,
- Modify RAID level/stripe size,
- Define pass-through disk drives,
- Modify system functions and
- Designate drives as hot spares.

## 3.3 Configuring Raid Sets and Volume Sets

You can configure RAID sets and volume sets with McBIOS RAID manager automatically. Using "Quick Volume/Raid Setup" or manually using "Raid Set/Volume Set Function". Each configuration method requires a different level of user input. The general flow of operations for RAID set and volume set configuration is:

Step	Action
1	Designate hot spares/pass-through drives (optional).
2	Choose a configuration method.
3	Create RAID sets using the available physical drives.
4	Define volume sets using the space available in the RAID set.
5	Initialize the volume sets and use volume sets (as logical drives) in the host OS.

## 3.4 Designating Drives as Hot Spares

Any unused disk drive that is not part of a RAID set can be designated as a hot spare. The "Quick Volume/Raid Setup" configuration will add the spare disk drive and automatically display the appropriate RAID level from which the user can select. For the "Raid Set Function" configuration option, the user can use the "Create Hot Spare" option to define the hot spare disk drive.

When a hot spare disk drive is being created using the "Create Hot Spare" option (in the Raid Set Function), all unused physical devices connected to the current controller appear:

Choose the target disk by selecting the appropriate check box. Press **Enter** key to select a disk drive, and press **Yes** in the "Create Hot Spare" to designate it as a hot spare.

# BIOS CONFIGURATION

## 3.5 Using Quick Volume /Raid Setup Configuration

“Quick Volume / Raid Setup configuration” collects all available drives and includes them in a RAID set. The RAID set you created is associated with exactly one volume set. You will only be able to modify the default RAID level, stripe size and capacity of the new volume set. Designating drives as hot spares is also possible in the “Raid Level” selection option. The volume set default settings will be:

Parameter	Setting
Volume Name	ARC-1212-VOL#00
SCSI Channel/SCSI ID/SCSI LUN	0/0/0
Cache Mode	Write Back
Tag Queuing	Yes

The default setting values can be changed after configuration is completed. Follow the steps below to create arrays using the “RAID Set / Volume Set” method:

Step	Action
1	Choose “Quick Volume /Raid Setup” from the main menu. The available RAID levels with hot spare for the current volume set drive are displayed.
2	<p>It is recommended that you use drives of the same capacity in a specific array. If you use drives with different capacities in an array, all drives in the RAID set will be set to the capacity of the smallest drive in the RAID set.</p> <p>The numbers of physical drives in a specific array determines which RAID levels that can be implemented in the array.</p> <p>RAID 0 requires 1 or more physical drives.</p> <p>RAID 1 requires at least 2 physical drives.</p> <p>RAID 10 requires at least 3 physical drives.</p> <p>RAID 3 requires at least 3 physical drives.</p> <p>RAID 5 requires at least 3 physical drives.</p> <p>RAID 3 +Spare requires at least 4 physical drives.</p> <p>RAID 5 + Spare requires at least 4 physical drives.</p> <p>RAID 6 requires at least 4 physical drives.</p> <p>RAID 6 + Spare requires at least 5 physical drives.</p> <p>Highlight the desired RAID level for the volume set and press the <b>Enter</b> key to confirm.</p>

# BIOS CONFIGURATION

3	The capacity for the current volume set is entered after highlighting the desired RAID level and pressing the <b>Enter</b> key. The capacity for the current volume set is displayed. Use the <b>UP</b> and <b>DOWN</b> arrow keys to set the capacity of the volume set and press the <b>Enter</b> key to confirm. The available stripe sizes for the current volume set are then displayed.
4	Use the <b>UP</b> and <b>DOWN</b> arrow keys to select the current volume set stripe size and press the <b>Enter</b> key to confirm. This parameter specifies the size of the stripes written to each disk in a RAID 0, 1, 10, 5 or 6 volume set. You can set the stripe size to 4 KB, 8 KB, 16 KB, 32 KB, 64 KB, or 128 KB. A larger stripe size provides better read performance, especially when the computer preforms mostly sequential reads. However, if the computer preforms random read requests more often, choose a smaller stripe size.
5	When you are finished defining the volume set, press the <b>Yes</b> key to confirm the "Quick Volume And Raid Set Setup" function.
6	Foreground (Fast Completion) Press <b>Enter</b> key to define fast initialization or selected the Background (Instant Available) or No Init (To Rescue Volume). In the "Background Initialization", the initialization proceeds as a background task, the volume set is fully accessible for system reads and writes. The operating system can instantly access to the newly created arrays without requiring a reboot and waiting the initialization complete. In "Foreground Initialization", the initialization proceeds must be completed before the volume set ready for system accesses. In "No Init", there is no initialization on this volume.
7	Initialize the volume set you have just configured
8	If you need to add additional volume set, using main menu "Create Volume Set" function.

## 3.6 Using RAID Set/Volume Set Function Method

In "Raid Set Function", you can use the "Create Raid Set" function to generate a new RAID set. In "Volume Set Function", you can use the "Create Volume Set" function to generate an associated volume set and configuration parameters.

If the current controller has unused physical devices connected, you can choose the "Create Hot Spare" option in the "Raid Set Function" to define a global hot spare. Select this method to configure new RAID sets and volume sets. The "Raid Set/Volume Set Function" configuration option allows you to associate volume sets with partial and full RAID sets.

# BIOS CONFIGURATION

Step	Action
1	To setup the hot spare (option), choose "Raid Set Function" from the main menu. Select the "Create Hot Spare" and press the <b>Enter</b> key to define the hot spare.
2	Choose "RAID Set Function" from the main menu. Select "Create Raid Set" and press the <b>Enter</b> key.
3	The "Select a Drive For Raid Set" window is displayed showing the SAS/SATA drives connected to the SAS RAID controller.
4	<p>Press the <b>UP</b> and <b>DOWN</b> arrow keys to select specific physical drives. Press the <b>Enter</b> key to associate the selected physical drive with the current RAID set.</p> <p>It is recommend that you use drives of the same capacity in a specific array. If you use drives with different capacities in an array, all drives in the RAID set will be set to the capacity of the smallest drive in the RAID set.</p> <p>The numbers of physical drives in a specific array determines which RAID levels that can be implemented in the array.</p> <p>RAID 0 requires 1 or more physical drives. RAID 1 requires at least 2 physical drives. RAID 10 requires at least 3 physical drives. RAID 3 requires at least 3 physical drives. RAID 5 requires at least 3 physical drives. RAID 6 requires at least 4 physical drives. RAID 30 requires at least 6 physical drives. RAID 50 requires at least 6 physical drives. RAID 60 requires at least 8 physical drives.</p>
5	After adding the desired physical drives to the current RAID set, press the <b>Enter</b> to confirm the "Create Raid Set" function.
6	An "Edit The Raid Set Name" dialog box appears. Enter 1 to 15 alphanumeric characters to define a unique identifier for this new RAID set. The default RAID set name will always appear as Raid Set. #. Press <b>Enter</b> to finish the name editing.
7	Press the <b>Enter</b> key when you are finished creating the current RAID set. To continue defining another RAID set, repeat step 3. To begin volume set configuration, go to step 8.
8	Choose the "Volume Set Function" from the main menu. Select "Create Volume Set" and press the <b>Enter</b> key.
9	Choose a RAID set from the "Create Volume From Raid Set" window. Press the <b>Yes</b> to confirm the selection.

# BIOS CONFIGURATION

10	Choosing Foreground (Fast Completion) Press <b>Enter</b> key to define fast initialization or selected the Background (Instant Available) or No Init (To Rescue Volume). In the "Background Initialization", the initialization proceeds as a background task, the volume set is fully accessible for system reads and writes. The operating system can instantly access to the newly created arrays without requiring a reboot and waiting the initialization complete. In "Foreground Initialization", the initialization proceeds must be completed before the volume set ready for system accesses. In "No Init", there is no initialization on this volume.
11	If space remains in the RAID set, the next volume set can be configured. Repeat steps 8 to 10 to configure another volume set.

## 3.7 Main Menu

The main menu shows all functions that are available for executing actions, which is accomplished by clicking on the appropriate link.

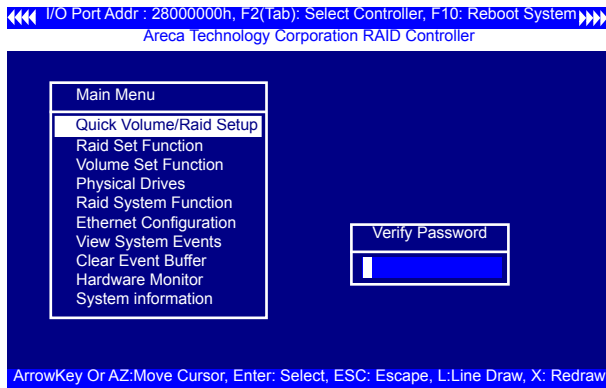

### **Note:**

The manufacture default password is set to **0000**; this password can be modified by selecting "Change Password" in the "Raid System Function" section.

# BIOS CONFIGURATION

Option	Description
Quick Volume/Raid Setup	Create a default configuration based on the number of physical disk installed
Raid Set Function	Create a customized RAID set
Volume Set Function	Create a customized volume set
Physical Drives	View individual disk information
Raid System Function	Setup the RAID system configuration
Ethernet Configuration	Ethernet LAN setting
View System Events	Record all system events in the buffer
Clear Event Buffer	Clear all information in the event buffer
Hardware Monitor	Show the hardware system environment status
System Information	View the controller system information

This password option allows user to set or clear the RAID controller's password protection feature. Once the password has been set, the user can only monitor and configure the RAID controller by providing the correct password. The password is used to protect the internal RAID controller from unauthorized entry. The controller will prompt for the password only when entering the main menu from the initial screen. The RAID controller will automatically return to the initial screen when it does not receive any command in twenty seconds.

## 3.7.1 Quick Volume/RAID Setup

"Quick Volume/RAID Setup" is the fastest way to prepare a RAID set and volume set. It requires only a few keystrokes to complete. Although disk drives of different capacity may be used in the RAID Set, it will use the capacity of the smallest disk drive as the capacity of all disk drives in the RAID Set. The "Quick Volume/RAID Setup" option creates a RAID set with the following properties:

1. All of the physical drives are contained in one RAID set.
2. The RAID level, hot spare, capacity, and stripe size options are selected during the configuration process.
3. When a single volume set is created, it can consume all or a portion of the available disk capacity in this RAID set.

# BIOS CONFIGURATION

4. If you need to add an additional volume set, use the main menu "Create Volume Set" function.

The total number of physical drives in a specific RAID set determine the RAID levels that can be implemented within the RAID set. Select "Quick Volume/Raid Setup" from the main menu; all possible RAID level will be displayed on the screen.

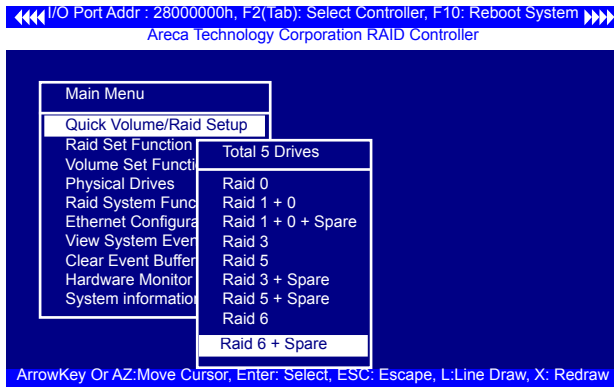

If volume capacity will exceed 2TB, controller will show the "Greater Two TB Volume Support" sub-menu.

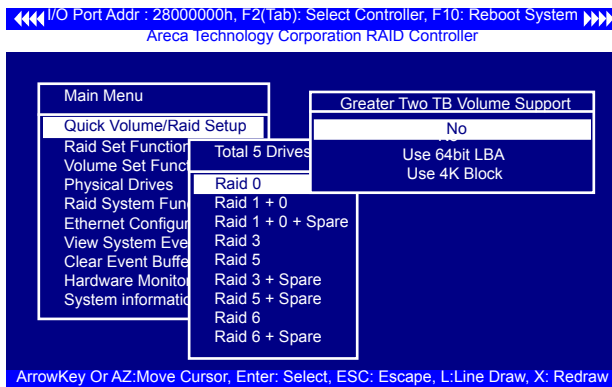

- **No**

It keeps the volume size with max. 2TB limitation.

- **LBA 64**

This option use 16 bytes CDB instead of 10 bytes. The maximum volume capacity up to 512TB.

# BIOS CONFIGURATION

This option works on different OS which supports 16 bytes CDB.  
Such as:  
Windows 2003 with SP1  
Linux kernel 2.6.x or latter

For more details, please download pdf file from [ftp://ftp.areca.com.tw/RaidCards/Documents/Manual\\_Spec/Over2TB\\_050721.zip](ftp://ftp.areca.com.tw/RaidCards/Documents/Manual_Spec/Over2TB_050721.zip)

A single volume set is created and consumes all or a portion of the disk capacity available in this RAID set. Define the capacity of volume set in the "Available Capacity" popup. The default value for the volume set, which is 100% of the available capacity, is displayed in the selected capacity. use the **UP** and **DOWN** arrow key to set capacity of the volume set and press **Enter** key to accept this value. If the volume set uses only part of the RAID set capacity, you can use the "Create Volume Set" option in the main menu to define additional volume sets.

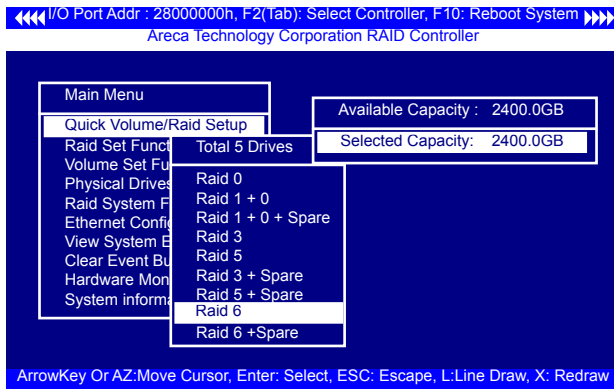

**Stripe Size** This parameter sets the size of the stripe written to each disk in a RAID 0, 1, 10, 5, or 6 logical drive. You can set the stripe size to 4 KB, 8 KB, 16 KB, 32 KB, 64 KB, or 128 KB.

# BIOS CONFIGURATION

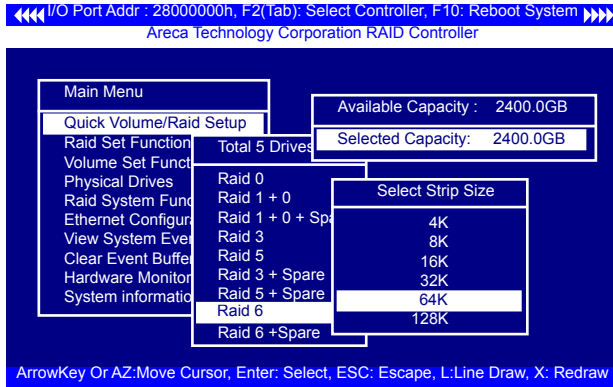

A larger stripe size produces better-read performance, especially if your computer does mostly sequential reads. However, if you are sure that your computer performs random reads more often, select a smaller stripe size.

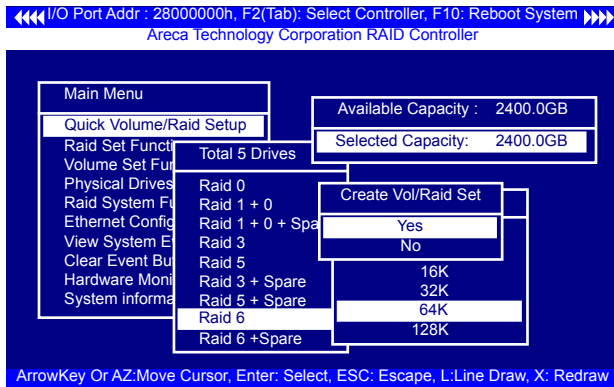

Press **Yes** key in the "Create Vol/Raid Set" dialog box, the RAID set and volume set will start to initialize it.

# BIOS CONFIGURATION

Select "Foreground (Faster Completion)" or "Background (Instant Available)" for initialization and "No Init (To Rescue Volume)" for recovering the missing RAID set configuration.

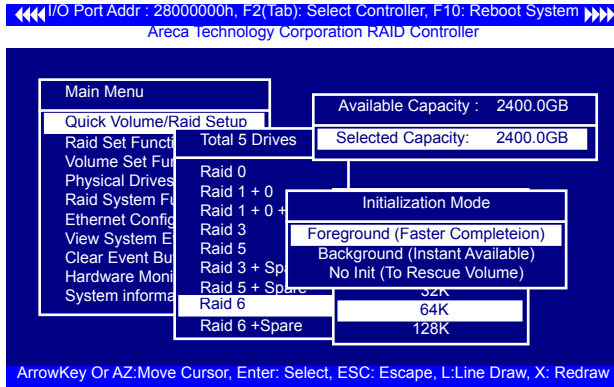

## 3.7.2 Raid Set Function

Manual configuration gives complete control of the RAID set setting, but it will take longer to configure than "Quick Volume/Raid Setup" configuration. Select "Raid Set Function" to manually configure the RAID set for the first time or delete existing RAID sets and reconfigure the RAID set.

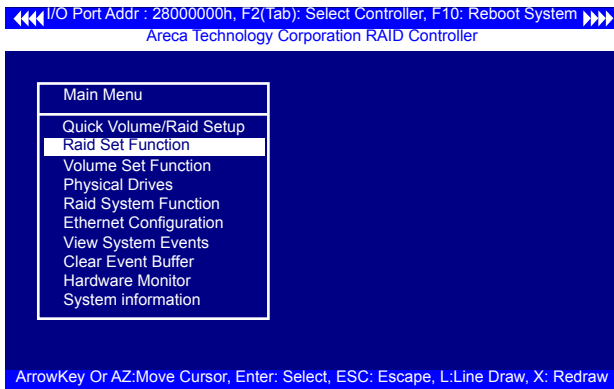

# BIOS CONFIGURATION

## 3.7.2.1 Create Raid Set

The following is the RAID set features for the SAS RAID controller.

1. Up to 8 disk drives can be included in a single RAID set.

To define a RAID set, follow the procedures below:

1. Select "Raid Set Function" from the main menu.
2. Select "Create Raid Set " from the "Raid Set Function" dialog box.
3. A "Select IDE Drive For Raid Set" window is displayed showing the SAS/SATA drives connected to the current controller. Press the **UP** and **DOWN** arrow keys to select specific physical drives. Press the **Enter** key to associate the selected physical drive with the current RAID set. Repeat this step; the user can add as many disk drives as are available to a single RAID set.

When finished selecting SAS/SATA drives for RAID set, press **Esc** key. A "Create Raid Set Confirmation" screen will appear, select the **Yes** option to confirm it.

4. An "Edit The Raid Set Name" dialog box appears. Enter 1 to

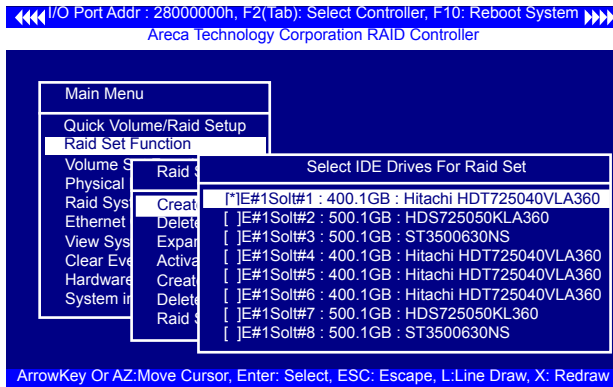

15 alphanumeric characters to define a unique identifier for the RAID set. The default RAID set name will always appear as Raid Set. #.

5. Repeat steps 3 to define another RAID sets.

# BIOS CONFIGURATION

## Note:

To create RAID 30/50/60 volume, you need create multiple RAID sets first with the same disk members on each RAID set. The max no. Disk drives per volume set: 8

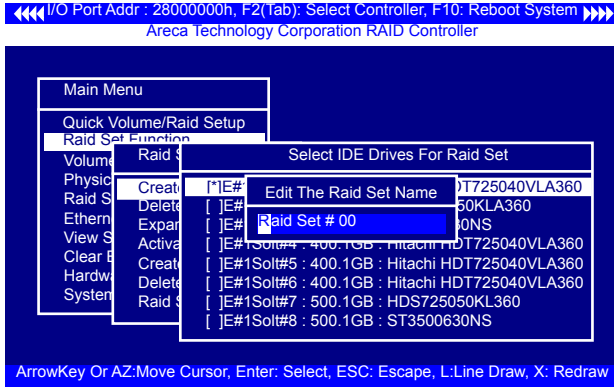

### 3.7.2.2 Delete Raid Set

To completely erase and reconfigure a RAID set, you must first delete it and re-create the RAID set. To delete a RAID set, select the RAID set number that you want to delete in the "Select Raid Set To Delete" screen. Then "Delete Raid Set" dialog box will appear, press the **Yes** key to delete it. Warning, data on RAID set will be lost if this option is used. But for deleting RAID set with the Raid 30/50/60 volume, firstly, you need to delete the volume belonging those RAID sets.

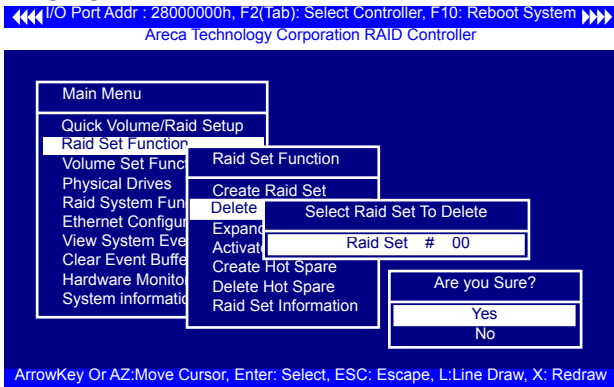

# BIOS CONFIGURATION

## 3.7.2.3 Expand Raid Set

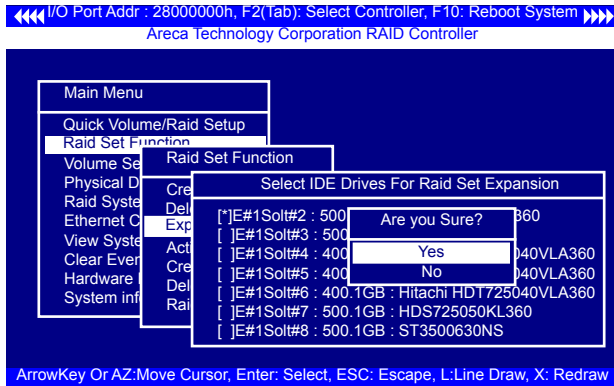

Instead of deleting a RAID set and recreating it with additional disk drives, the "Expand RAID Set" function allows the users to add disk drives to the RAID set that have already been created. To expand a RAID set:

Select the "Expand RAID Set" option. If there is an available disk, then the "Select SATA Drives For RAID Set Expansion" screen appears.

Select the target RAID set by clicking on the appropriate radio button. Select the target disk by clicking on the appropriate check box.

Press the **Yes** key to start the expansion on the RAID set.

The new additional capacity can be utilized by one or more volume sets. The volume sets associated with this RAID set appear for you to have chance to modify RAID level or stripe size. Follow the instruction presented in the "Modify Volume Set" to modify the volume sets; operation system specific utilities may be required to expand operating system partitions.

### Note:

1. Once the "Expand RAID Set" process has started, user can not stop it. The process must be completed.
2. If a disk drive fails during raid set expansion and a hot spare is available, an auto rebuild operation will occur after the RAID set expansion completes.
3. RAID 30/50/60 doesn't support the "Expand RAID Set".

# BIOS CONFIGURATION

## • Migrating

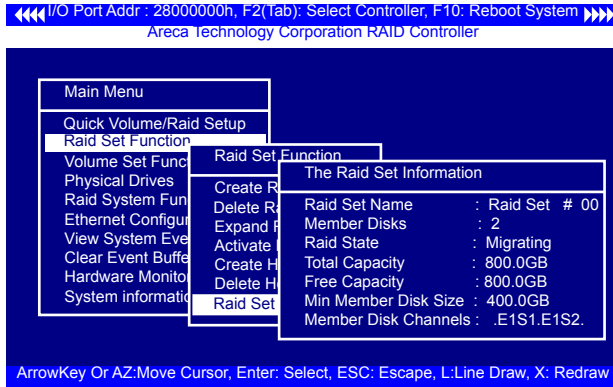

Migration occurs when a disk is added to a RAID set. Migrating state is displayed in the RAID state area of "The Raid Set Information" screen when a disk is being added to a RAID set. Migrating state is also displayed in the associated volume state area of the "Volume Set Information" which belongs this RAID set.

### 3.7.2.4 Activate Incomplete Raid Set

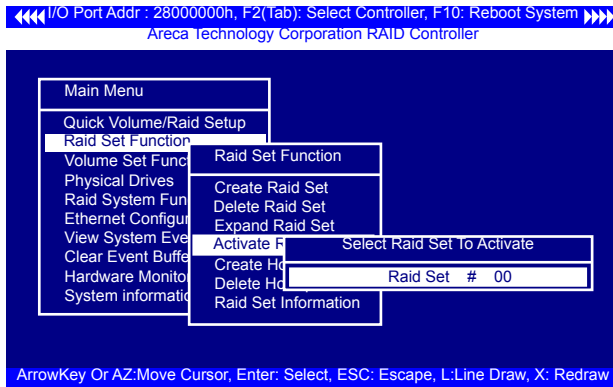

The following screen is used to activate the RAID set after one of its disk drive was removed in the power off state. When one of the disk drives is removed in power off state, the RAID set state will change to "Incomplete State". If user wants to continue to work while the SAS RAID controller is powered on, the user can use the "Activate Incomplete Raid Set" option

# BIOS CONFIGURATION

to active the RAID set. After user selects this function, the RAID state will change to "Degraded Mode" and start to work.

## 3.7.2.5 Create Hot Spare

When you choose the "Create Hot Spare" option in the "Raid Set Function", all unused physical devices connected to the current controller will result in the screen.

Select the target disk by clicking on the appropriate check box. Press the **Enter** key to select a disk drive and press **Yes** key in the "Create Hot Spare" to designate it as a hot spare.

The "Create Hot Spare" option gives you the ability to define a global hot spare.

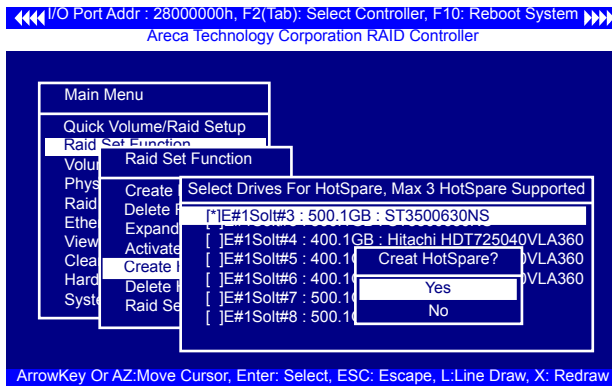

## 3.7.2.6 Delete Hot Spare

Select the target hot spare disk to delete by clicking on the appropriate check box.

Press the **Enter** key to select a hot spare disk drive, and press **Yes** in the "Delete Hot Spare" screen to delete the hot spare.

# BIOS CONFIGURATION

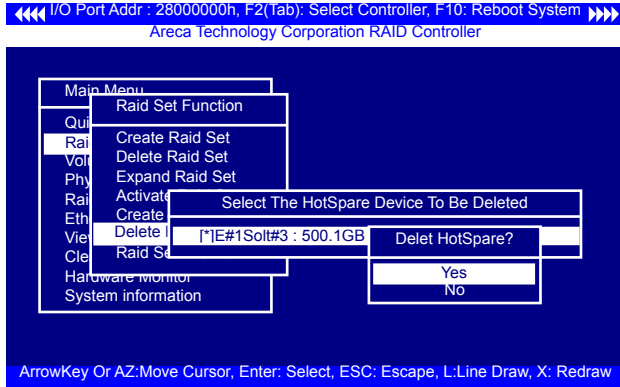

## 3.7.2.7 Raid Set Information

To display RAID set information, move the cursor bar to the desired RAID set number, then press the **Enter** key. The "Raid Set Information" will appear.

You can only view information for the RAID set in this screen.

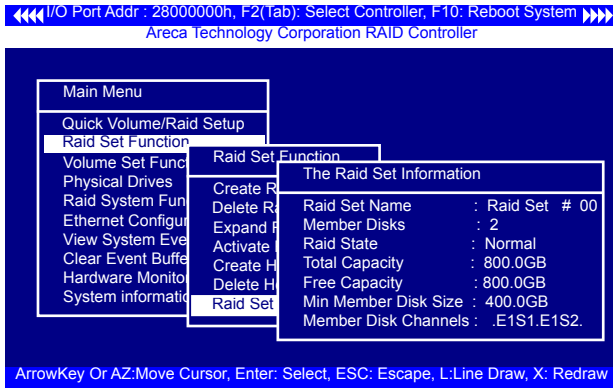

## 3.7.3 Volume Set Function

A volume set is seen by the host system as a single logical device; it is organized in a RAID level within the controller utilizing one or more physical disks. RAID level refers to the level of data performance and protection of a volume set. A volume set can consume all of the capacity or a portion of the available disk capacity of a RAID set. Multiple volume sets can exist on a RAID

# BIOS CONFIGURATION

set. If multiple volume sets reside on a specified RAID set, all volume sets will reside on all physical disks in the RAID set. Thus each volume set on the RAID set will have its data spread evenly across all the disks in the RAID set rather than one volume set using some of the available disks and another volume set using other disks.

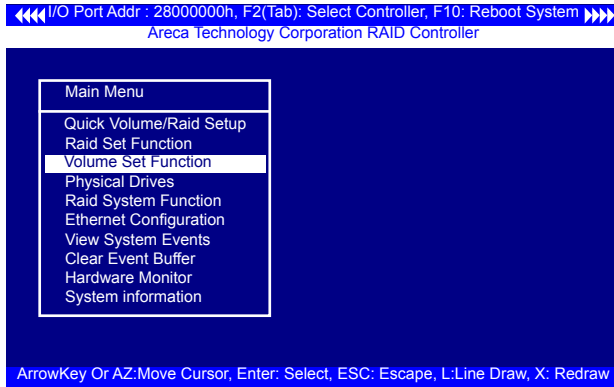

The following is the volume set features for the SAS RAID controller.

1. Volume sets of different RAID levels may coexist on the same RAID set.
2. Up to 128 volume sets can be created in a RAID set.
3. The maximum addressable size of a single volume set is not limited to 2TB, because the controller is capable of 64-bit LBA mode. However the operating system itself may not be capable of addressing more than 2TB.

See Areca website [ftp://ftp.areca.com.tw/RaidCards/Documents/Manual\\_Spec/Over2TB\\_050721.ZIP](ftp://ftp.areca.com.tw/RaidCards/Documents/Manual_Spec/Over2TB_050721.ZIP) file for details.

# BIOS CONFIGURATION

## 3.7.3.1 Create Volume Set (0/1/10/3/5/6)

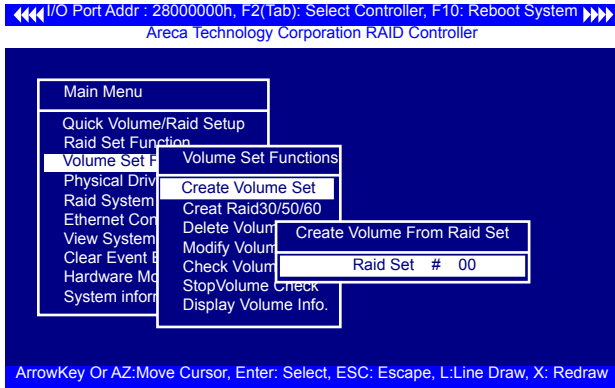

To create a volume set, following the steps:

1. Select the "Volume Set Function" from the main menu.
2. Choose the "Create Volume Set" from "Volume Set Functions" dialog box screen.
3. The "Create Volume From Raid Set" appears. This screen displays the existing arranged RAID sets. Select the RAID set number and press the **Enter** key. The "Volume Creation" dialog is displayed in the screen.
4. The new create volume set attribute allows user to select the Volume Name, RAID level, Capacity, Strip Size, SCSI Channel/ SCSI ID/SCSI Lun, Cache Mode, Tagged Command Queuing .

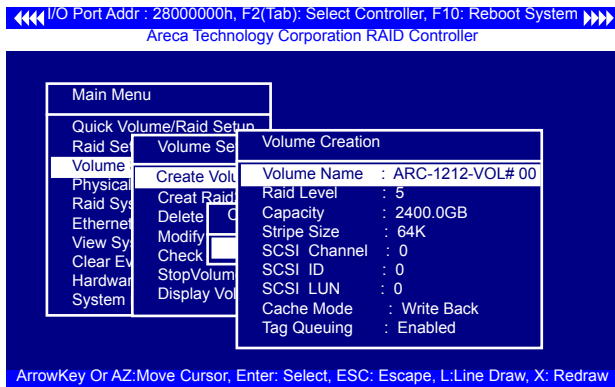

# BIOS CONFIGURATION

5. After completed the modification of the volume set, press the **Esc** key to confirm it. An "Initialization Mode" screen appears.

- Select "Foreground (Faster Completion)" for faster initialization of the selected volume set.
- Select "Background (Instant Available)" for normal initialization of the selected volume set.
- Select "No Init (To Rescue Volume)" for no initialization of the selected volume

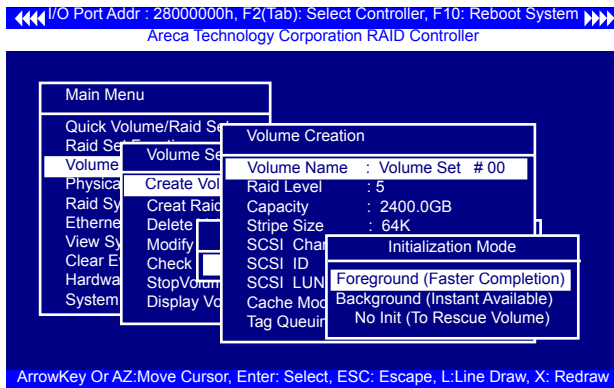

6. Repeat steps 3 to 5 to create additional volume sets.

7. The initialization percentage of volume set will be displayed at the bottom line.

## • Volume Name

The default volume name will always appear as ARC-1212-VOL #. You can rename the volume set providing it does not exceed the 15 characters limit.

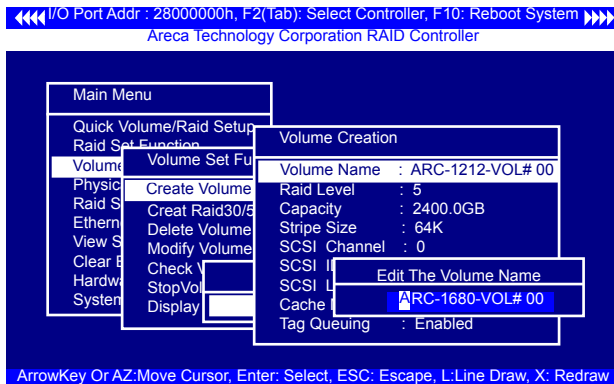

# BIOS CONFIGURATION

## ● Raid Level

Set the RAID level for the volume set. Highlight RAID Level and press the **Enter** key. The available RAID levels for the current volume set are displayed. Select a RAID level and press the **Enter** key to confirm.

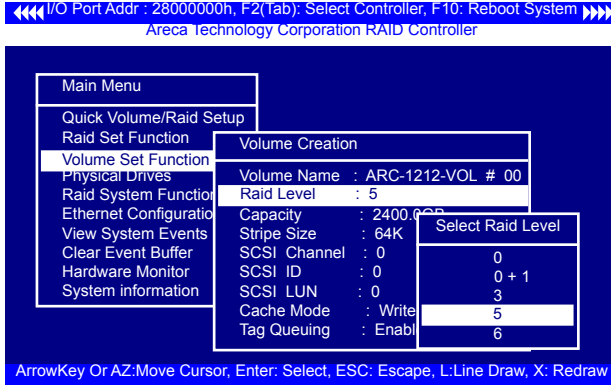

## ● Capacity

The maximum available volume size is the default value for the first setting. Enter the appropriate volume size to fit your application. The capacity value can be increased or decreased by the **UP** and **DOWN** arrow keys. The capacity of each volume set must be less than or equal to the total capacity of the RAID set on which it resides.

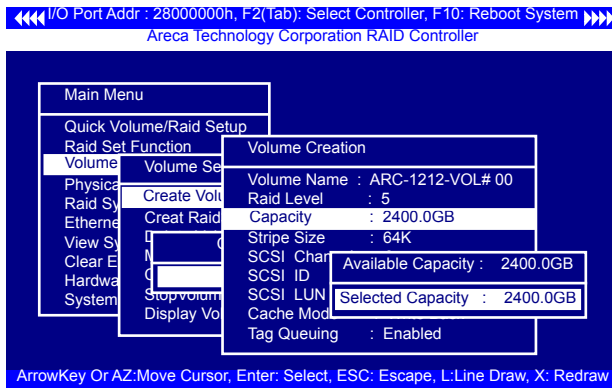

# BIOS CONFIGURATION

If volume capacity will exceed 2TB, controller will show the "Greater Two TB Volume Support" sub-menu.

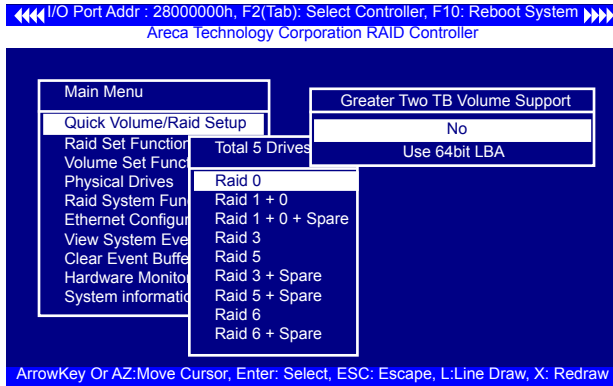

- **No**

It keeps the volume size with max. 2TB limitation.

- **LBA 64**

This option uses 16 bytes CDB instead of 10 bytes. The maximum volume capacity up to 512TB.

This option works on different OS which supports 16 bytes CDB. Such as:

Windows 2003 with SP1

Linux kernel 2.6.x or latter

For more details, please download pdf file from [ftp://ftp.areca.com.tw/RaidCards/Documents/Manual\\_Spec/Over2TB\\_050721.zip](ftp://ftp.areca.com.tw/RaidCards/Documents/Manual_Spec/Over2TB_050721.zip)

- **Stripe Size**

This parameter sets the size of segment written to each disk in a RAID 0, 1, 10, 5, 6, 50 or 60 logical drive. You can set the stripe size to 4 KB, 8 KB, 16 KB, 32 KB, 64 KB, or 128 KB.

# BIOS CONFIGURATION

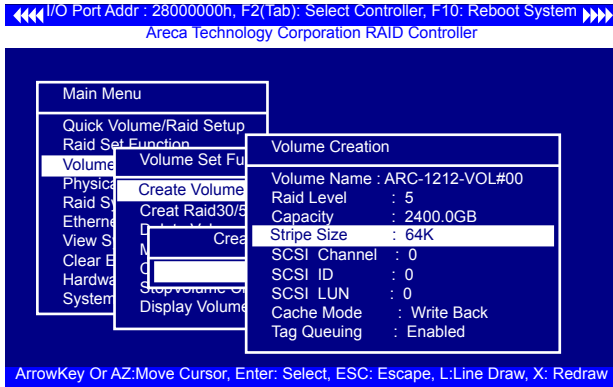

## ● SCSI Channel

The SAS RAID controller function simulates an external SCSI RAID controller. The host bus represents the SCSI channel. Choose the "SCSI Channel". A "Select SCSI Channel" dialog box appears; select the channel number and press the **Enter** key to confirm it.

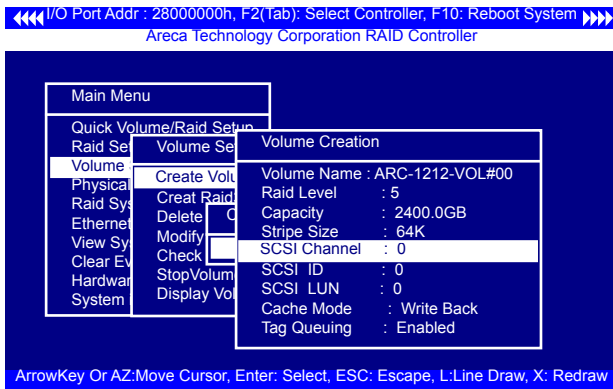

## ● SCSI ID

Each device attached to the SAS RAID controller, as well as the SAS RAID controller itself, must be assigned a unique SCSI ID number. A SCSI channel can connect up to 15 devices. It is necessary to assign a SCSI ID to each device from a list of available SCSI IDs.

# BIOS CONFIGURATION

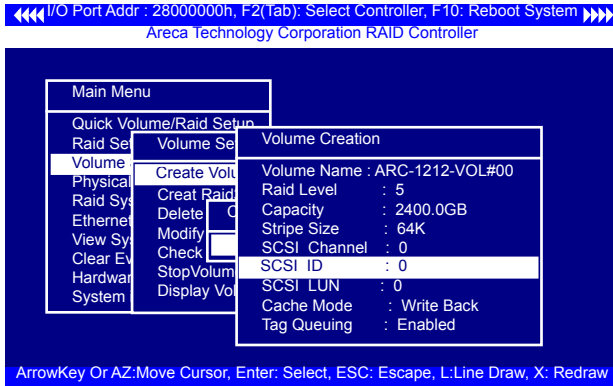

## ● SCSI LUN

Each SCSI ID can support up to 8 LUNs. Most SAS controllers treat each LUN as if it were a SAS disk.

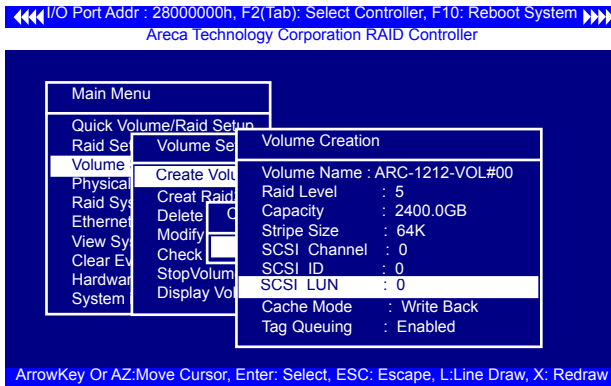

## ● Cache Mode

User can set the cache mode to either "Write Through" or "Write Back".

# BIOS CONFIGURATION

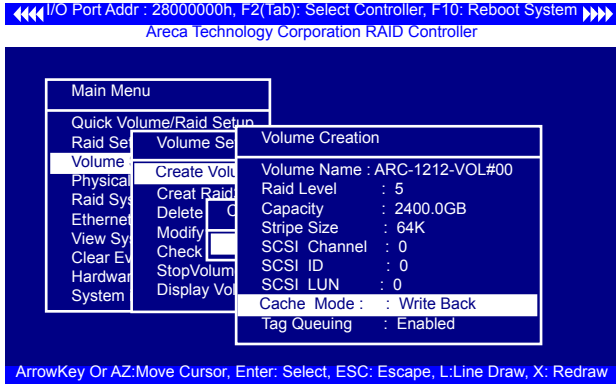

## • Tag Queuing

This option, when enabled, can enhance overall system performance under multi-tasking operating systems. The Command Tag (Drive Channel) function controls the SAS command tag queuing support for each drive channel. This function should normally remain enabled. Disabled this function only when using older drives that do not support command tag queuing.

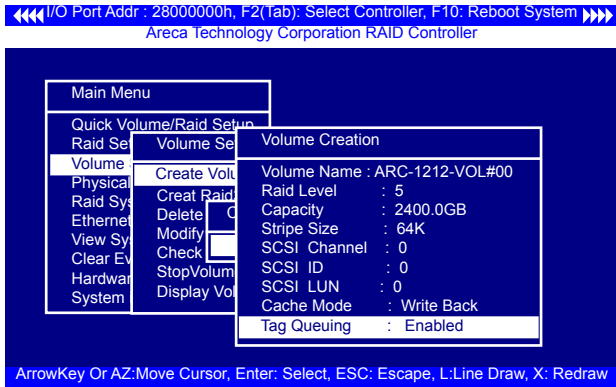

### 3.7.3.2 Create Raid30/50/60 (Volume Set 30/50/60)

To create 30/50/60 volume set from RAID set group, move the cursor bar to the main menu and click on the "Create Raid30/50/60" link. The "Select The Raid Set To Create Volume On It" screen will show all RAID set number. Tick on the RAID set numbers (same disk No per RAID set) that you want to create and then click on it.

# BIOS CONFIGURATION

The created new volume set attribute option allows users to select the Volume Name, Capacity, RAID Level, Strip Size, SCSI ID/LUN, Cache Mode, and Tagged Command Queuing. The detailed description of those parameters can refer to section 3.7.3.1. User can modify the default values in this screen; the modification procedures are in section 3.7.3.4.

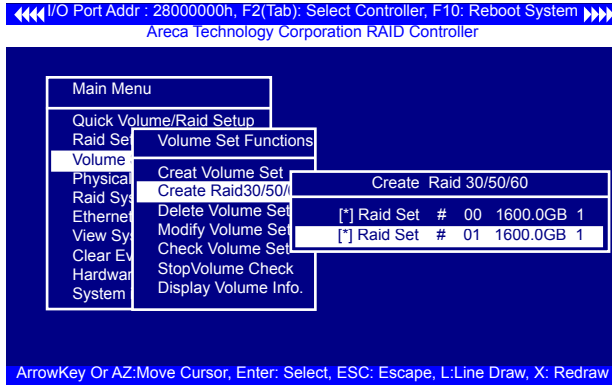

## Note:

ARC-1212 4-port SAS/SATA controller does not support Raid30/50/60. There is no action on this configuration when it is appeared. RAID level 30, 50 and 60 can not support expansion and migration.

### 3.7.3.3 Delete Volume Set

To delete volume set from a RAID set, move the cursor bar to the "Volume Set Functions" menu and select the "Delete Volume Set" item, then press the **Enter** key. The "Volume Set Functions" menu will show all Raid Set # items. Move the cursor bar to a RAID set number, then press the **Enter** key to show all volume sets within that RAID set. Move the cursor to the volume set number that is to be deleted and press the **Enter** to delete it.

## Note:

ARC-1212 4-port SAS/SATA does not support Raid 30/50/60. There is no action on this configuration when it is appeared.

# BIOS CONFIGURATION

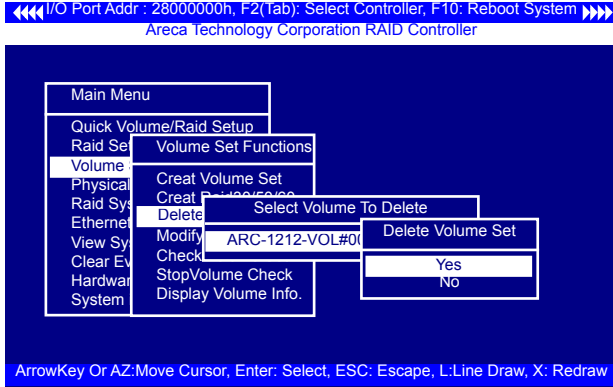

### 3.7.3.4 Modify Volume Set

Use this option to modify volume set configuration. To modify volume set values from RAID set system function, move the cursor bar to the "Modify Volume Set" item, then press the **Enter** key. The "Volume Set Functions" menu will show all RAID set items. Move the cursor bar to a RAID set number item, then press the **Enter** key to show all volume set items. Select the volume set from the list to be changed, press the **Enter** key to modify it.

As shown, volume information can be modified at this screen. Choose this option to display the properties of the selected volume set. But user can only modify the last volume set capacity.

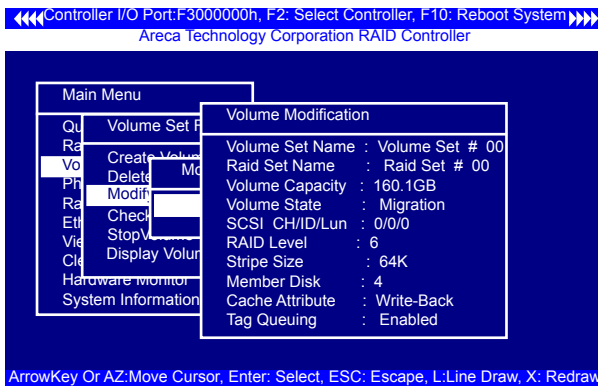

# BIOS CONFIGURATION

---

## 3.7.3.4.1 Volume Growth

Use "Expand RAID Set" function to add disk to a RAID set. The additional capacity can be used to enlarge the last volume set size or to create another volume set. The "Modify Volume Set" function can support the "Volume Modification" function. To expand the last volume set capacity, move the cursor bar to the "Capacity" item and enter the capacity size. When finished the above action, press the **ESC** key and select the **Yes** option to complete the action. The last volume set starts to expand its capacity.

### **To expand an existing volume noticed:**

- Only the last volume can expand capacity.
- When expand volume capacity, you can't modify stripe size or modify RAID level simultaneously.
- You can expand volume capacity, but can't reduce volume capacity size.
- After volume expansion, the volume capacity can't be decreased.

### **For greater 2TB expansion:**

- If your system installed in the volume, don't expand the volume capacity greater 2TB, currently OS can't support boot up from a greater 2TB capacity device.
- Expand over 2TB used LBA64 mode. Please make sure your OS supports LBA64 before expand it.

## 3.7.3.4.2 Volume Set Migration

Migrating occurs when a volume set is migrating from one RAID level to another, when a volume set strip size changes, or when a disk is added to a RAID set. Migration state is displayed in the volume state area of the "Volume Set Information" screen.

# BIOS CONFIGURATION

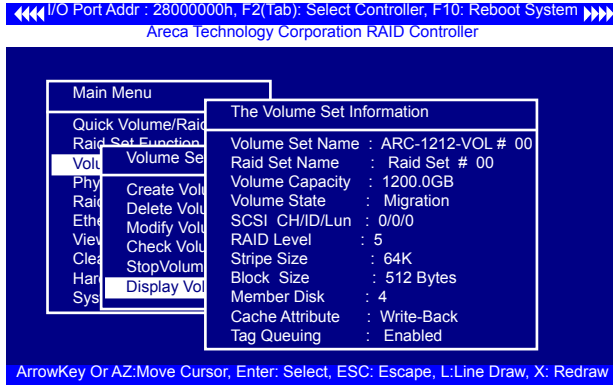

## 3.7.3.5 Check Volume Set

Use this option to verify the correctness of the redundant data in a volume set. For example, in a system with a dedicated parity disk drive, a volume set check entails computing the parity of the data disk drives and comparing those results to the contents of the dedicated parity disk drive. To check volume set, move the cursor bar to the "Check Volume Set" item, then press the **Enter** key. The "Volume Set Functions" menu will show all RAID set number items. Move the cursor bar to an RAID set number item and then press the **Enter** key to show all volume set items. Select the volume set to be checked from the list and press **Enter** to select it. After completed the selection, the confirmation screen appears, press **Yes** to start the check.

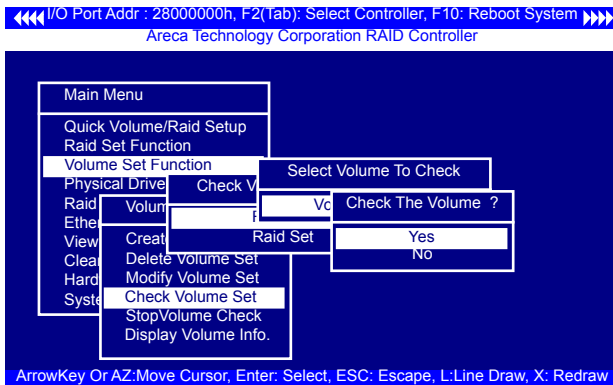

# BIOS CONFIGURATION

## 3.7.3.6 Stop Volume Set Check

Use this option to stop all of the "Check Volume Set" operations.

## 3.7.3.7 Display Volume Set Info.

To display volume set information, move the cursor bar to the desired volume set number and then press the **Enter** key. The "Volume Set Information" screen will be shown. You can only view the information of this volume set in this screen, but can not modify it.

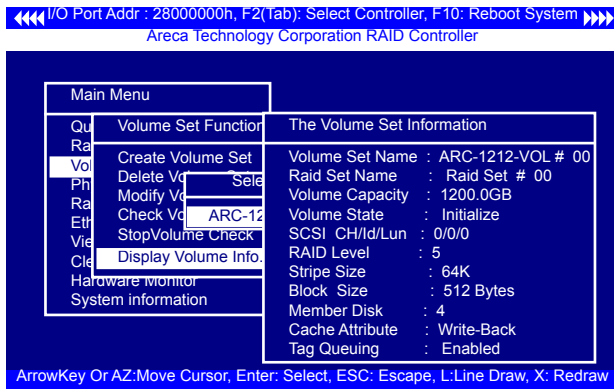

## 3.7.4 Physical Drives

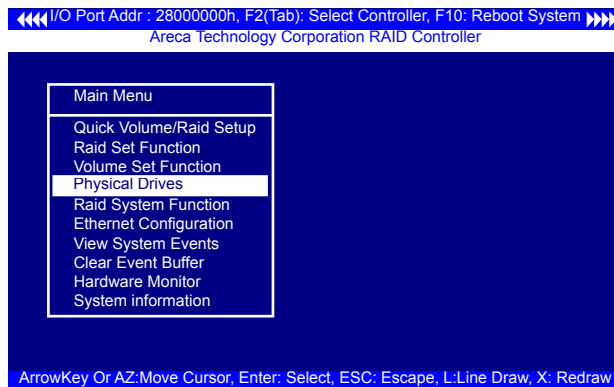

# BIOS CONFIGURATION

Choose this option from the main menu to select a physical disk and perform the operations listed above. Move the cursor bar to an item, then press **Enter** key to select the desired function.

## 3.7.4.1 View Drive Information

When you choose this option, the physical disks connected to the SAS RAID controller are listed. Move the cursor to the desired drive and press **Enter** key to view drive information.

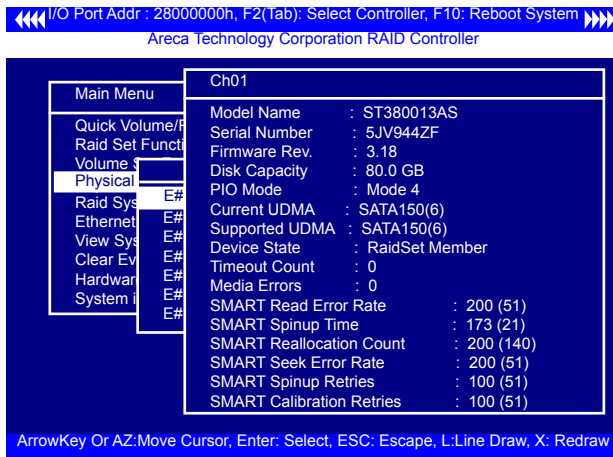

## 3.7.4.2 Create Pass-Through Disk

A pass-through disk is not controlled by the SAS RAID controller firmware and thus cannot be a part of a volume set. The disk is available directly to the operating system as an individual disk. It is typically used on a system where the operating system is on a disk not controlled by the SAS RAID controller firmware. The SCSI Channel, SCSI ID, SCSI LUN, Cache Mode, and Tag Queuing must be specified to create a pass-through disk.

# BIOS CONFIGURATION

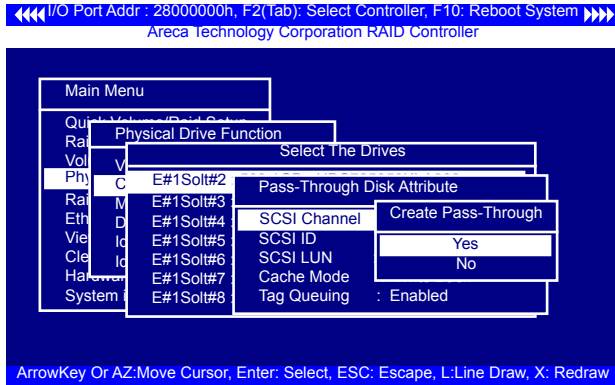

### 3.7.4.3 Modify a Pass-Through Disk

Use this option to modify "Pass-Through Disk Attributes". To select and modify a pass-through disk from the pool of pass-through disks, move the "Modify Pass-Through Drive" option and then press the **Enter** key. The "Physical Drive Function" menu will show all pass-through drive number options. Move the cursor bar to the desired number and then press the **Enter** key to show all pass-through disk attributes. Select the parameter from the list to be changed and then press the **Enter** key to modify it.

### 3.7.4.4 Delete Pass-Through Disk

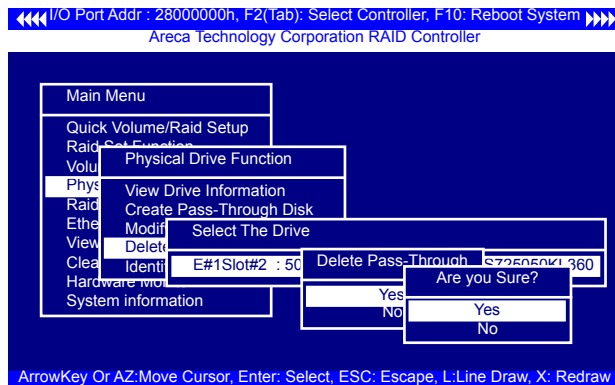

# BIOS CONFIGURATION

To delete a pass-through drive from the pass-through drive pool, move the cursor bar to the "Delete Pass-Through Drive" item, then press the **Enter** key. The "Delete Pass-Through confirmation" screen will appear; select **Yes** to delete it.

## 3.7.4.5 Identify Selected Drive

To prevent removing the wrong drive, the selected disk fault LED Indicator will light for physically locating the selected disk when the "Identify Selected Device" is selected.

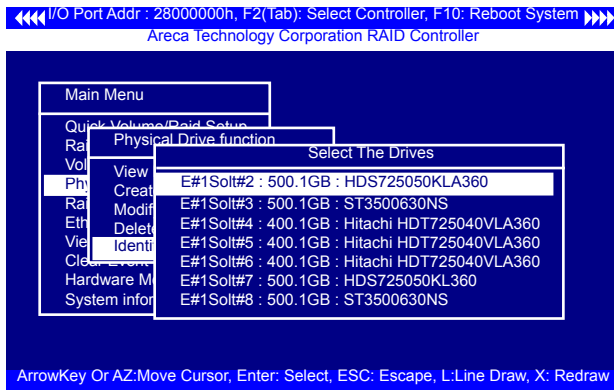

## 3.7.5 Raid System Function

To set the "Raid System Function", move the cursor bar to the main menu and select the "Raid System Function" item and then press **Enter** key. The "Raid System Function" menu will show multiple items. Move the cursor bar to an item, then press **Enter** key to select the desired function.

# BIOS CONFIGURATION

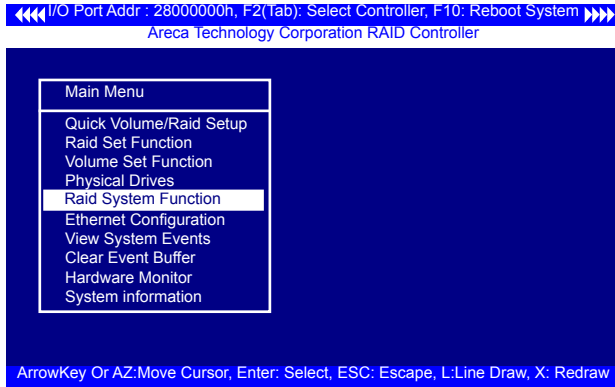

## 3.7.5.1 Mute The Alert Beeper

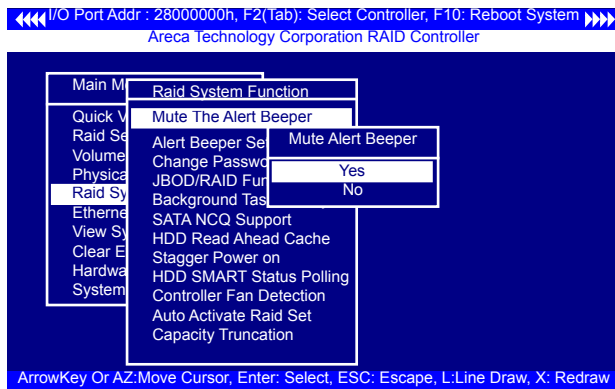

The "Mute The Alert Beeper" function item is used to control the SAS RAID controller Beeper. Select **Yes** and press the **Enter** key in the dialog box to turn the beeper off temporarily. The beeper will still activate on the next event.

## 3.7.5.2 Alert Beeper Setting

The "Alert Beeper Setting" function item is used to "Disabled" or "Enabled" the SAS RAID controller alarm tone generator. Select "Disabled" and press the **Enter** key in the dialog box to turn the beeper off.

# BIOS CONFIGURATION

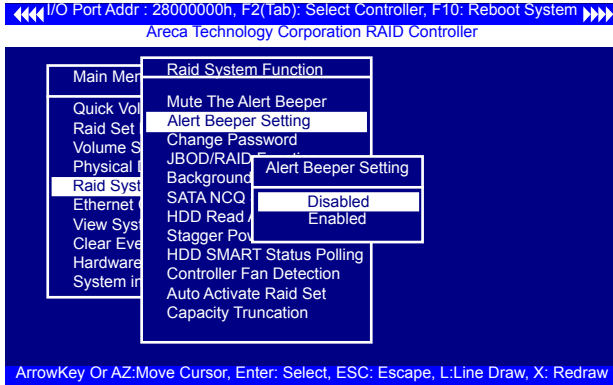

## 3.7.5.3 Change Password

**The manufacture default password is set to 0000.** The password option allows user to set or clear the password protection feature. Once the password has been set, the user can monitor and configure the controller only by providing the correct password. This feature is used to protect the internal RAID system from unauthorized access. The controller will check the password only when entering the main menu from the initial screen. The system will automatically go back to the initial screen if it does not receive any command in 5 minutes. Do not use spaces when you enter the password, If spaces are used, it will lock out the user. To set or change the password, move the cursor to "Raid System Function" screen, press the "Change Password" item. The "Enter New Password" screen will appear.

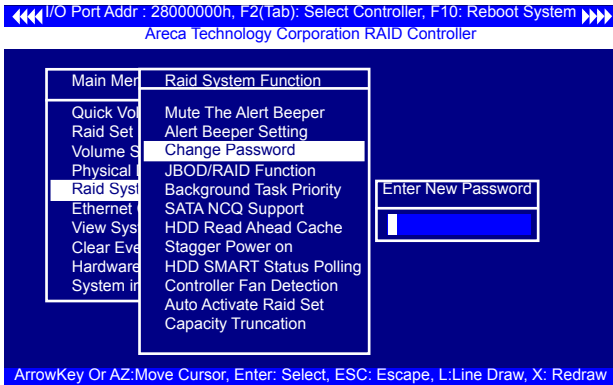

# BIOS CONFIGURATION

To disable the password, only press **Enter** key in both the "Enter New Password" and "Re-Enter New Password" column. The existing password will be cleared. No password checking will occur when entering the main menu.

## 3.7.5.4 JBOD/RAID Function

JBOD is an acronym for "Just a Bunch Of Disk". A group of hard disks in a RAID box are not set up as any type of RAID configuration. All drives are available to the operating system as an individual disk. JBOD does not provide data redundancy. User needs to delete the RAID set, when you want to change the option from the RAID to the JBOD function.

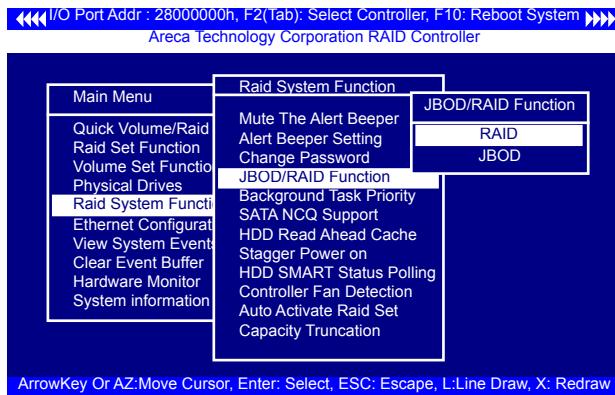

## 3.7.5.5 Background Task Priority

The "Background Task Priority" is a relative indication of how much time the controller devotes to a rebuild operation. The SAS RAID controller allows the user to choose the rebuild priority (UltraLow, Low, Normal, High) to balance volume set access and rebuild tasks appropriately.

# BIOS CONFIGURATION

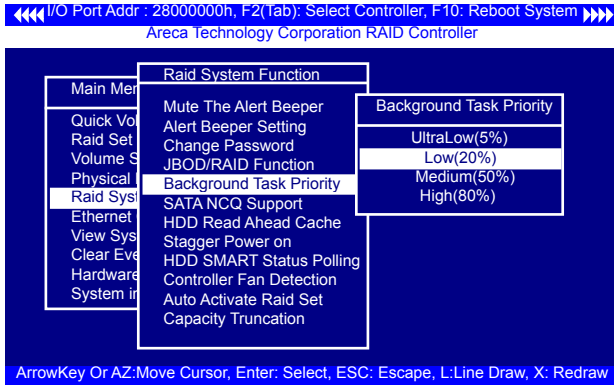

## 3.7.5.6 SATA NCQ Support

The controller supports both SAS and SATA disk drives. The SATA NCQ allows multiple commands to be outstanding within a drive at the same time. Drives that support NCQ have an internal queue where outstanding commands can be dynamically rescheduled or re-ordered, along with the necessary tracking mechanisms for outstanding and completed portions of the workload. The SAS RAID controller allows the user to select the SATA NCQ support: "Enabled" or "Disabled".

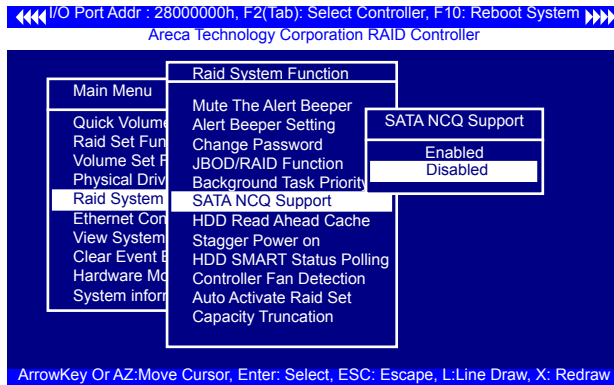

# BIOS CONFIGURATION

## 3.7.5.7 HDD Read Ahead Cache

Allow Read Ahead (Default: Enabled)—When Enabled, the drive's read ahead cache algorithm is used, providing maximum performance under most circumstances.

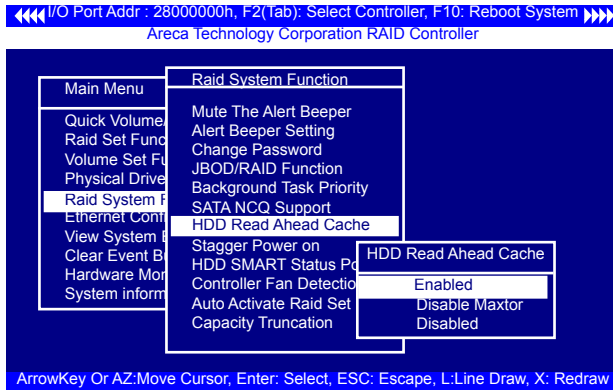

## 3.7.5.8 Stagger Power On

In a PC system with only one or two drives, the power can supply enough power to spin up both drives simultaneously. But in systems with more than two drives, the startup current from spinning up the drives all at once can overload the power supply, causing damage to the power supply, disk drives and other system components. This damage can be avoided by allowing the host to stagger the spin-up of the drives. The SAS/SATA drives have support stagger spin-up capabilities to boost reliability. Stagger spin-up is a very useful feature for managing multiple disk drives in a storage subsystem. It gives the host the ability to spin up the disk drives sequentially or in groups, allowing the drives to come ready at the optimum time without straining the system power supply. Staggering drive spin-up in a multiple drive environment also avoids the extra cost of a power supply designed to meet short-term startup power demand as well as steady state conditions.

Areca RAID controller has included the option for customer to select the disk drives sequentially stagger power up value. The

# BIOS CONFIGURATION

values can be selected from 0.4s to 6s per step which powers up one drive.

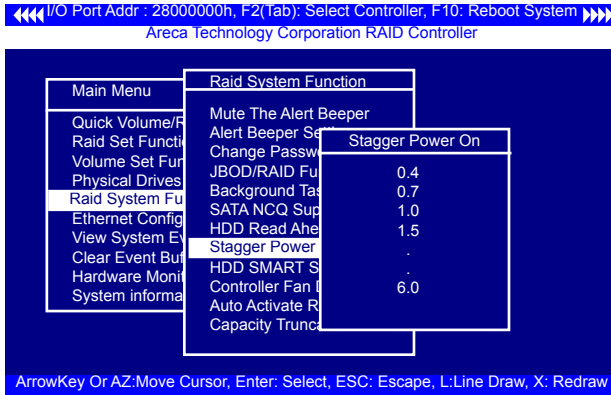

## 3.7.5.9 Controller Fan Detection

Included in the product box is a field replaceable passive heat-sink to be used only if there is enough airflow to adequately cool the passive heatsink.

The "Controller Fan Detection" function is available in the firmware for preventing the buzzer warning. When using the passive heatsink, disable the "Controller Fan Detection" function through this McBIOS RAID manager setting.

The following screen shot shows how to change the McBIOS RAID manager setting to disable the beeper function. **(This function is not available in the web browser setting.)**

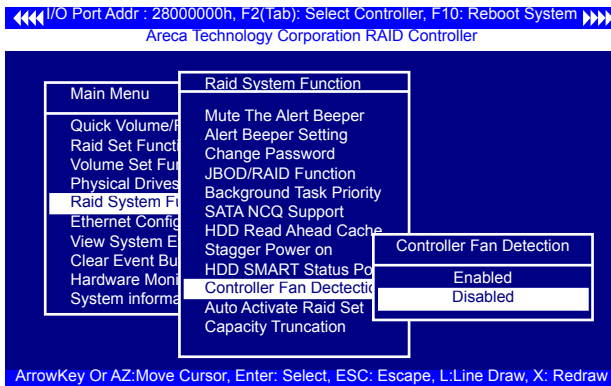

# BIOS CONFIGURATION

## 3.7.5.10 Auto Activate Raid Set

When some of the disk drives are removed in power off state or boot up stage, the RAID set state will change to "Incomplete State". But if a user wants to automatically continue to work while the SAS RAID controller is powered on, then user can set the "Auto Activate Raid Set" option to "Enabled". The RAID state will change to "Degraded Mode" while it powers on.

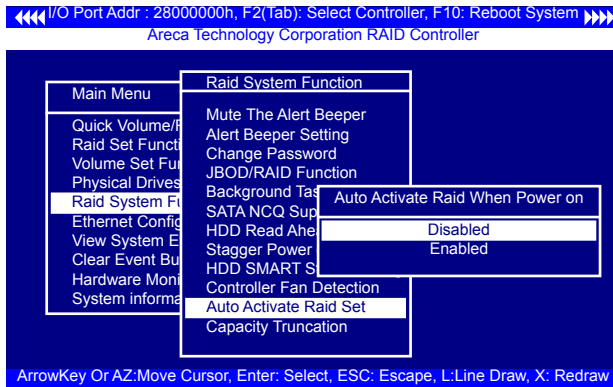

## 3.7.5.11 Capacity Truncation

Areca RAID controllers use drive truncation so that drives from different vendors are more likely to be usable as spares for one another. Drive truncation slightly decreases the usable capacity of a drive that is used in redundant units. The controller provides three truncation modes in the system configuration: Multiples Of 10G, Multiples Of 1G and Disabled.

**Multiples Of 10G:** If you have 120 GB drives from different vendors; chances are that the capacity varies slightly. For example, one drive might be 123.5 GB, and the other 120 GB. "Multiples Of 10G" truncates the number under tens. This makes the same capacity for both of these drives so that one could replace the other.

**Multiples Of 1G:** If you have 123 GB drives from different vendors; chances are that the capacity varies slightly. For example, one drive might be 123.5 GB, and the other 123.4 GB. "Multiples Of 1G" truncates the fractional part. This makes the

# BIOS CONFIGURATION

same capacity for both of these drives so that one could replace the other.

**No Truncation:** It does not truncate the capacity.

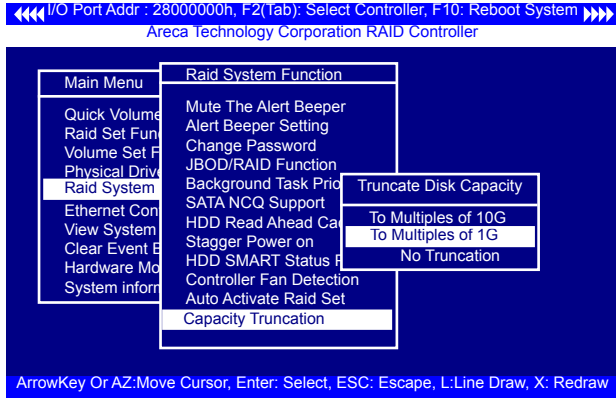

## 3.7.6 Ethernet Configuration

Use this feature to set the controller Ethernet port configuration. It is not necessary to create reserved disk space on any hard disk for the Ethernet port and HTTP service to function; these functions are built into the controller firmware. Move the cursor bar to the main menu "Ethernet Configuration Function" item and then press the **Enter** key. The "Ethernet Configuration" menu appears on the screen. Move the cursor bar to an item, then press **Enter** key to select the desired function.

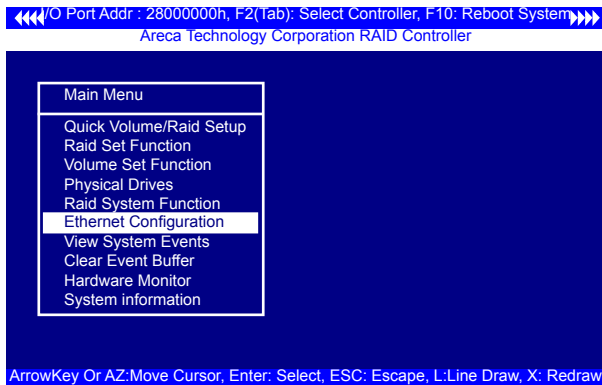

# BIOS CONFIGURATION

## 3.7.6.1 DHCP Function

DHCP (Dynamic Host Configuration Protocol) allows network administrators centrally manage and automate the assignment of IP (Internet Protocol) addresses on a computer network. When using the TCP/IP protocol (Internet protocol), it is necessary for a computer to have a unique IP address in order to communicate to other computer systems. Without DHCP, the IP address must be entered manually at each computer system. DHCP lets a network administrator supervise and distribute IP addresses from a central point. The purpose of DHCP is to provide the automatic (dynamic) allocation of IP client configurations for a specific time period (called a lease period) and to minimize the work necessary to administer a large IP network. To manually configure the IP address of the controller, move the cursor bar to DHCP Function item, then press **Enter** key to show the DHCP setting. Select the "Disabled" or "Enabled" option to enable or disable the DHCP function. If DHCP is disabled, it will be necessary to manually enter a static IP address that does not conflict with other devices on the network.

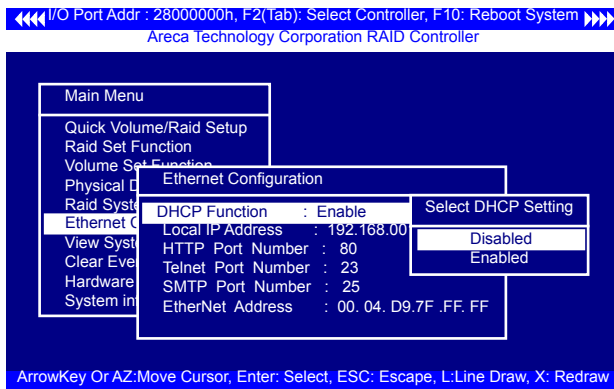

## 3.7.6.2 Local IP address

If you intend to set up your client computers manually (no DHCP), make sure that the assigned IP address is in the same range as the default router address and that it is unique to your private network. However, it is highly recommend to use DHCP if that option is available on your network. An IP address allocation scheme will reduce the time it takes to set-up client com-

# BIOS CONFIGURATION

puters and eliminate the possibilities of administrative errors and duplicate addresses. To manually configure the IP address of the controller, move the cursor bar to Local IP address item, then press the **Enter** key to show the default address setting in the RAID controller. You can then reassign the static IP address of the controller.

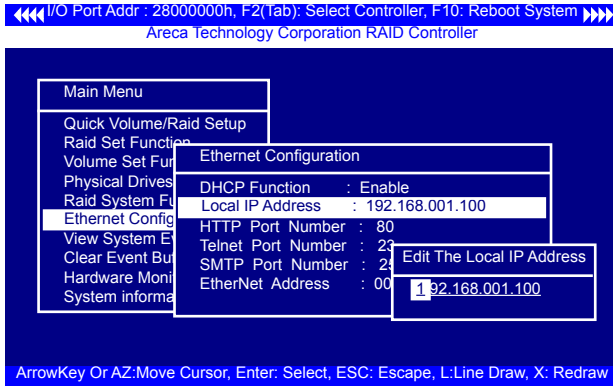

### 3.7.6.3 HTTP Port Number

To manually configure the "HTTP Port Number" of the controller, move the cursor bar to "HTTP Port Number" item, then press the **Enter** key to show the default address setting in the RAID controller. Then You can reassign the default "HTTP Port Number" of the controller.

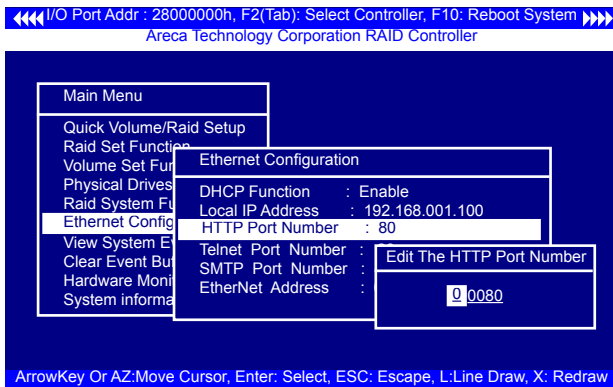

# BIOS CONFIGURATION

## 3.7.6.4 Telnet Port Number

To manually configure the “Telnet Port Number” of the controller, move the cursor bar to “Telnet Port Number” item, then press the **Enter** key to show the default address setting in the RAID controller. You can then reassign the default “Telnet Port Number” of the controller.

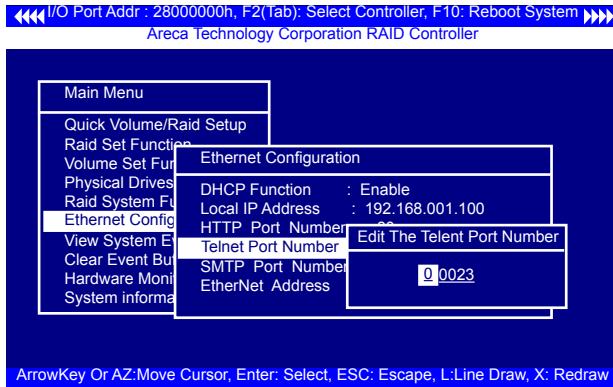

## 3.7.6.5 SMTP Port Number

To manually configure the “SMTP Port Number” of the controller, move the cursor bar to the main menu “Ethernet Configuration” function item and then press **Enter** key. The “Ethernet Configuration” menu appears on the screen. Move the cursor bar to “SMTP Port Number” item, then press **Enter** key to show the default address setting in the RAID controller. You can then reassign the default “SMTP Port Number” of the controller.

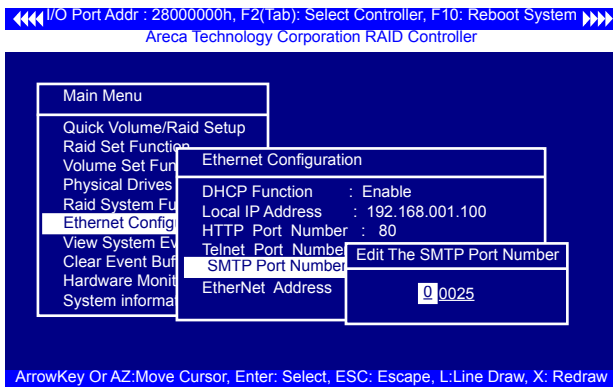

# BIOS CONFIGURATION

## 3.7.6.6 Ethernet Address

Each Ethernet port has its unique Mac address, which is also factory assigned. Usually, Ethernet address is used to uniquely identify a port in the Ethernet network.

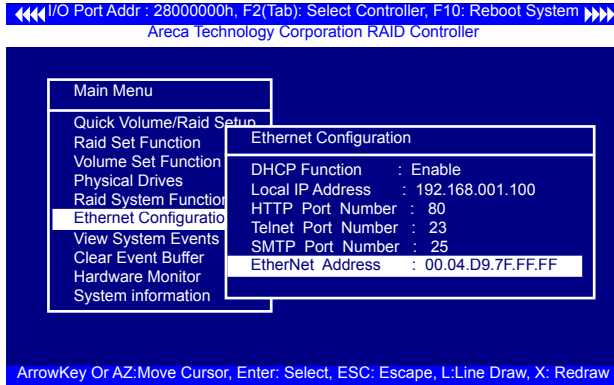

## 3.7.7 View System Events

To view the SAS RAID controller’s system events information, move the cursor bar to the main menu and select the “View System Events” link, then press the **Enter** key. The SAS RAID controller’s events screen appear.

Choose this option to view the system events information: Timer, Device, Event type, Elapsed Time, and Errors. The RAID system does not have a build-in real time clock. The time information is the relative time from the SAS RAID controller powered on.

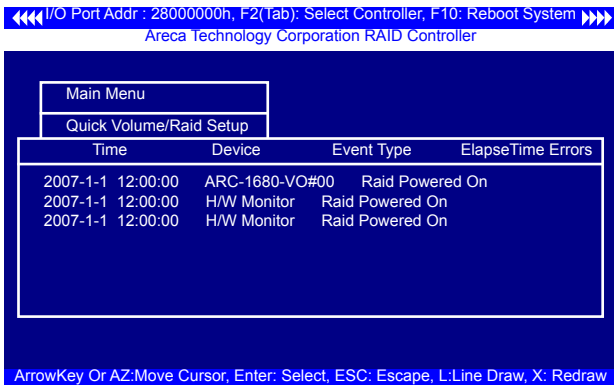

# BIOS CONFIGURATION

## 3.7.8 Clear Events Buffer

Use this feature to clear the entire events buffer.

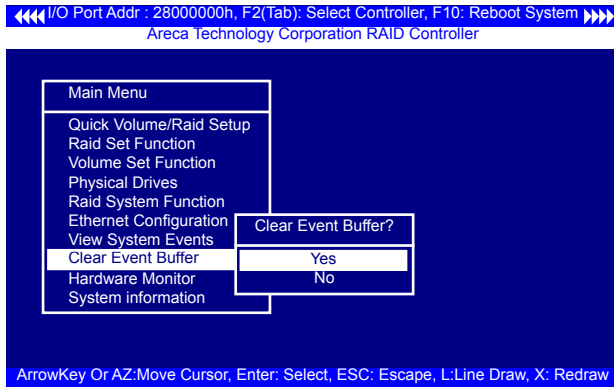

## 3.7.9 Hardware Monitor

To view the RAID controller's hardware monitor information, move the cursor bar to the main menu and click the "Hardware Monitor" link. The "Controller H/W Monitor" screen appears.

The "Controller H/W Monitor" provides the CPU Temperature, Controller Temperature, Voltage and Fan speed (I/O Processor fan) of the SAS RAID controller.

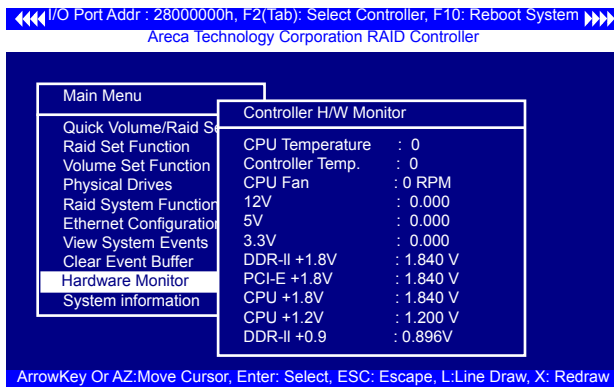

# BIOS CONFIGURATION

## 3.7.10 System Information

Choose this option to display controller name, firmware version, BOOT ROM version, SAS firmware version, serial number, main processor, CPU instruction cache and data cache size, system memory, and current IP address. To check the system information, move the cursor bar to "System Information" item, then press **Enter** key. All relevant controller information will be displayed.

◀◀◀ I/O Port Addr : 28000000h, F2(Tab): Select Controller, F10: Reboot System ▶▶▶  
Areca technology Corporation RAID Controller

Main Menu	The System Information
Quick Volume/Raid	Controller Name : ARC-1212
Raid Set Function	Firmware Version : V1.43 2007-5-15
Volume Set Function	BOOT ROM Version : V1.43 2007-5-15
Physical Drives	SAS Firmware Version : 2.1.2.4
Raid System Function	Serial Number : 1100-2116-6633
Ethernet Configuration	Unit Serial # :
View System Event	Main Processor : 667MHz IOP348
Clear Event Buffer	CPU ICache Size : 32KBytes
Hardware Monitor	CPU DCache Size : 32KBytes/Write Back
System Information	CPU SCache Size : 512KBytes/Write Back
	System Memory : 256MB/533MHz/ECC
	Current IP Address : 192.168.0.55

ArrowKey Or AZ:Move Cursor, Enter: Select, ESC: Escape, L:Line Draw, X: Redraw

## 4. Driver Installation

This chapter describes how to install the SAS RAID controller driver to your operating system. The installation procedures use the following terminology:

### **Installing operating system on the SAS/SATA Volume**

If you have a new drive configuration without an operating system and want to install operating system on a disk drive managed by the SAS RAID Controller. The driver installation is a part of the operating system installation.

### **Installing SAS RAID controller into an existing operating system**

The computer has an existing operating system installed and the SAS RAID controller is being installed as a secondary controller.

Have all required system hardware and software components on hand before proceeding with the setup and installation.

Materials required:

- Microsoft Windows 2000/XP/2003/Vista, or Linux, or FreeBSD installation CD
- SAS RAID controller software CD
- SAS RAID controller

### **4.1 Creating the Driver Diskettes**

The software CD disc shipped with the SAS RAID controller is a self-booting CD. In order to create driver diskettes for Windows, Linux, and FreeBSD installation drivers, your system is required to support booting from the CD-ROM.

If you do not have the software CD disc with the package, contact your local dealers or you can also download the latest version drivers for Windows 2000/XP/2003/Vista, Linux, FreeBSD, Solaris and Mac from the Areca web site at <http://www.areca.com.tw>

These driver diskettes are intended for use with new operating

# DRIVER INSTALLATION

---

system installations. Determine the correct kernel version and identify which diskette images contain drivers for that kernel. If the driver file ends in .img, create the appropriate driver diskette using "dd" utility. The following steps are required to create the driver diskettes:

1. The computer system BIOS must be set to boot-up from the CD-ROM.
2. Insert the SATA controller driver CD disc into the CD-ROM drive.
3. The system will boot-up from CD-ROM Drive.

## **Note:**

It will take about 5 minutes to boot up the Knoppix GNU/Linux, Live Linux CD.

4. To create the driver diskette, for example: making the CentOS 5 driver diskette.
  - 4a. Execute xterm by clicking the XTerm icon on left-bottom toolbar.
  - 4b. Change the path to the specific driver image.  
`cd /cdrom/PACKAGES/Linux/DRIVER/CentOS_5`
  - 4c. Dump the driver image into floppy diskette using "dd" utility, Command format: `dd if=<image file> of=<destination>`  
`dd if=driver.img of=/dev/fd0`
  - 4d. When the operation is complete, the following messages are shown.  
2880+0 records in  
2880+0 records out  
1474560 bytes (1.5 MB) copied, 97.5903 seconds, 15.1 kB/s

The driver diskette is made now. Proceed to the following instruction for installation procedures.

# DRIVER INSTALLATION

---

## 4.2 Driver Installation for Windows

The SAS RAID controller can be used with Microsoft Windows 2000/XP/2003/Vista. The SAS RAID controllers support SCSI Miniport and StorPort Drivers for Windows Server 2003/Vista.

### 4.2.1 New Storage Device Drivers in Windows 2003/XP-64/Vista

The Storport driver is new to Windows Server 2003/XP-64/Vista. Storport implements a new architecture designed for better performance with RAID systems and in Storage Area Network (SAN) environments. Storport delivers higher I/O throughput, enhanced manageability, and an improved miniport interface. Storport better utilizes faster adapters through the use of reduced Delay Procedure Call (DPC) and improved queue management.

### 4.2.2 Install Windows 2000/XP/2003/Vista on a SAS/SATA RAID Volume

The following instructions explain how to install the SAS RAID controller device driver. For completed details on installing Windows, see the Windows User's Manual.

#### 4.2.2.1 Installation Procedures

The following procedures detail installing the SAS RAID controller driver while installing Windows 2000/XP/2003/Vista. Have your bootable Microsoft Windows 2000/XP/2003/Vista CD and follow the required procedure below to install SAS RAID controller:

1. Make sure you follow the instructions in Chapter 2 "Hardware Installation" to install the controller and connect the disk drives or enclosure.
2. Start the system and then press **Tab+F6** to access the McBIOS RAID manager. Use the McBIOS RAID manager to create the RAID set and volume set to which you will install Windows. For details, see Chapter 3 "McBIOS RAID manager". Once a

# DRIVER INSTALLATION

---

volume set is created and configured, continue with next step to install the operating system.

3. Insert the Windows setup CD and reboot the system to begin the Windows installation.

## **Note:**

The computer system BIOS must support bootable from CD-ROM.

4. Press **F6** key as soon as the Windows screen shows "Setup is inspecting your computer's hardware configuration". A message stating "Press F6 to specify third-party RAID controller" will display during this time. This must be done or else the Windows installer will not prompt for the driver from the SAS RAID controller and the driver diskette will not be recognized.

5. The next screen will show: "Setup could not determine the type of one or more mass storage device installed in your system. "Selected "specify additional SCSI controller" by pressing S.

6. Window will prompt to place the "Manufacturer-supplied hardware support disk" into floppy drive A:. Insert the SAS RAID series driver diskette in drive "A:" and press **Enter** key.

7. Window will check the floppy; select the correct card and CPU type for your hardware from the listing and press **Enter** key to install it.

8. After Windows scans the hardware and finds the controller, it will display:  
"Setup will load support for the following mass storage devices:"  
"ARECA[Windows X86-64 Storport] SATA/SAS PCI RAID Host Controller(RAID6-Engine Inside)". Press **Enter** key to continue and copy the driver files. From this point on, simply follow the Microsoft Windows installation procedure. Follow the on-screen instructions, responding as needed, to complete the installation.

# DRIVER INSTALLATION

---

9. After the installation is completed, reboot the system to load the new driver/operating system.
10. See Chapter 5 in this manual to customize your RAID volume sets using McRAID Storage Manager.

## **4.2.2.2 Making Volume Sets Available to Windows System**

When you reboot the system, log in as a system administrator. Continue with the following steps to make any additional volume sets or pass-through disks accessible to Windows. This procedure assumes that the SAS RAID controller hardware, driver, and Windows are installed and operational in your system.

1. Partition and format the new volume set or disks using "Disk Administrator":
  - a. Choose "Administrative Tools" from the "Start" menu.
  - b. Choose "Computer Management" from the "Administrative Tools" menu.
  - c. Select "Storage".
  - d. Select "Disk Management".
2. Follow the on-screen prompts to write a signature to the drive.
3. Right click on the disk drive and select "Create Volume" from the menu.
4. Follow the on-screen prompts to create a volume set and to give a disk drive letter.

## **4.2.3 Installing controller into an existing Windows 2000/XP/2003/Vista Installation**

In this scenario, you are installing the controller in an existing Windows system. To install the driver:

# DRIVER INSTALLATION

---

1. Follow the instructions in Chapter 2, the Hardware Installation Chapter, to install the controller and connect the disk drives or enclosure.
2. Start the system and then press **Tab+F6** to enter the controller McBIOS RAID manager. Use the configuration utility to create the RAID set and volume set. For details, see Chapter 3, McBIOS RAID Manager. Once a volume set is created and configured, continue with installation of the driver.
3. Re-Boot Windows and the OS will recognize the SAS RAID controller and launch the "Found New Hardware Wizard", which guides you in installing the SAS RAID driver.
4. The "Upgrade Device Driver Wizard" will pop-up and provide a choice of how to proceed. Choose "Display a list of known drivers for this device, so that you can choose a specific driver." and click on "Next".
5. When the next screen queries the user about utilizing the currently installed driver, click on the "Have Disk" button.
6. When the "Install From Disk" dialog appears, insert the SAS RAID controller driver diskette or the shipping software CD and type-in or browse to the correct path for the "Copy Manufacturer's Files from:" dialog box.
7. After specifying the driver location, the previous dialog box will appear showing the selected driver to be installed. Click the "Next" button.
8. The "Digital Signature Not Found" screen will appear. Click on **Yes** option to continue the installation.
9. Windows automatically copies the appropriate driver files and rebuilds its driver database.
10. The "Found New Hardware Wizard" summary screen appears; click the "Finish" button.
11. The "System Settings Change" dialog box appears. Remove

# DRIVER INSTALLATION

---

the diskette from the drive and click **Yes** to restart the computer to load the new drivers.

12. See Chapter 5 in this manual for information on customizing your RAID volumes using McRAID Storage Manager.

## **4.2.3.1 Making Volume Sets Available to Windows System**

When you reboot the system, log in as a system administrator. The following steps show how to make any new disk arrays or independent disks accessible to Windows 2000/XP/2003/Vista. This procedure assumes that the SAS RAID controller hardware, driver, and Windows are installed and operational in your system.

1. Partition and format the new arrays or disks using "Disk Administrator":
  - a. Choose "Administrative Tools" from the "Start" menu.
  - b. Choose "Computer Management" from the "Administrative Tools" menu.
  - c. Select "Storage".
  - d. Select "Disk Management".
2. Follow the on-screen prompts to write a signature to the drive.
3. Right click on the drive and select "Create Volume" from the menu.
4. Follow the on-screen prompts to create a volume set and to assign a disk drive letter.

## **4.2.4 Uninstall controller from Windows 2000/XP/2003/Vista**

To remove the SAS RAID controller driver from the Windows system, follow the instructions below.

# DRIVER INSTALLATION

---

1. Ensure that you have closed all applications and are logged in with administrative rights.
2. Open "Control Panel" and start the "Add/Remove Program" icon and uninstall and software for the SAS RAID controller.
3. Go to "Control Panel" and select "System". Select the "Hardware" tab and then click the "Device Manager" button. In device manager, expand the "SCSI and RAID Controllers" section. Right click on the Areca SAS RAID controller and select "Uninstall".
4. Click **Yes** to confirm removing the SAS RAID driver. The prompt to restart the system will then be displayed.

## 4.3 Driver Installation for Linux

This chapter describes how to install the SAS RAID controller driver to Red Hat Linux, SuSE and other versions of Linux. Before installing the SAS RAID driver to the Linux, complete the following actions:

1. Install and configure the controller and hard disk drives according to the instructions in Chapter 2 Hardware Installation.
2. Start the system and then press **Tab+F6** to enter the McBIOS RAID manager configuration utility. Using the McBIOS RAID manager to create the RAID set and volume set. For details, see Chapter 3, McBIOS RAID Manager.

If you are using a Linux distribution for which there is not a compiled driver available from Areca, you can copy the source from the SAS software CD or download the source from the Areca website and compile a new driver.

Compiled and tested drivers for Red Hat and SuSE Linux are included on the shipped CD. You can download updated versions of compiled and tested drivers for RedHat or SuSE Linux from the Areca web site at <http://www.areca.com.tw>. Included in these downloads is the Linux driver source, which can be used to compile the updat-

# DRIVER INSTALLATION

---

ed version driver for RedHat, SuSE and other versions of Linux. Please refer to the "readme.txt" file on the included Areca CD or website to make driver diskette and to install driver to the system.

## 4.4 Driver Installation for FreeBSD

This chapter describes how to install the SAS RAID controller driver to FreeBSD. Before installing the SAS RAID driver to FreeBSD, complete following actions:

1. Install and configure the controller and hard disk drives according to the instructions in Chapter 2, Hardware Installation.
2. Start the system and then press **Tab+F6** to enter the McBIOS RAID Manager configuration utility. Use the McBIOS RAID manager to create the RAID set and volume set. For details, see Chapter 3, McBIOS RAID Manager.

The supplied software CD that came with the SAS RAID controller includes compiled and tested drivers for FreeBSD 4.x (4.2 and onwards) and 5.x (5.2 and onwards). To check if a more current version driver is available, please see the Areca web site at <http://www.areca.com.tw>.

Please refer to the "readme.txt" file on the SAS RAID controller software CD or website to make driver diskette and to install driver to the system.

## 4.5 Driver Installation for Solaris

Please refer to the "readme.txt" file on the software CD or website: <http://www.areca.com.tw>

## 4.6 Driver Installation for Mac X

After hardware installation, the SATA disk drives connected to the SATA RAID Adapter must be configured and the volume set units initialized by the controller before they are ready to use by the system.

# DRIVER INSTALLATION

---

You must have administrative level permissions to install Areca Mac driver & software. You can install driver& software on your Power Mac G5 or Mac Pro as below:

1. Insert the Areca Mac driver & software CD that came with your Areca SAS RAID controller.
2. Double-click on the following file that resides at <CD-ROM>\packages\MacOS to add the installer on the Finder.
  - a). install\_mraid\_mac.zip (For Power Mac G5)
  - b). install\_mraid\_macpro.zip (For Mac Pro)
3. Launch the installer by double-clicking the install\_mraid\_mac or install\_mraid\_macpro on the Finder.
4. Follow the installer steps to install Areca driver, MRAID (archttp64 and arc\_cli utility) at the same time.



5. Reboot your Power Mac G5 or Mac Pro system.

Normally archttp64 and arc\_cli are installed at the same time on Areca SATA RAID adapter. Once archttp64 and arc\_cli have been installed, the background task automatically starts each time when you start your computer. There is one MARID icon showing on your desktop. This icon is for you to start up the McRAID storage manager (by archttp64) and arc\_cli utility. You can also only upgrade the driver, archttp64 or arc\_cli individual item that resides at <CD-ROM>\packages\MacOS Arc-cli performs many tasks at the command line. You can download arc-cli manual from Areca website or software CD <CDROM>\ DOCS directory.

## 5. ArcHttp Proxy Server Installation

### Overview

After hardware installation, the SAS/SATA disk drives connected to the SAS RAID controller must be configured and the volume set units initialized before they are ready to use.

The user interface for these tasks can be accessed through the built-in configuration that resides in the controller's firmware. It provides complete control and management of the controller and disk arrays, eliminating the need for additional hardware or software.

In addition, a software utility to configure the SAS RAID is provided on the software CD delivered with SAS RAID controller. This software CD contains the software utility that can monitor, test, and support the SAS RAID controller. The software utility and McRAID storage manager can configure and monitor the SAS RAID controller via ArcHttp proxy server interface. The following table outlines their functions:

Configuration Utility	Operating System supported
McBIOS RAID Manager	OS-Independent
McRAID Storage Manager (Via Archttp proxy server)	Windows 2000/XP/2003/Vista, Linux, FreeBSD, Solaris and Mac
SAP Monitor (Single Admin portal to scan for multiple RAID units in the network, Via Archttp Proxy Server)	Windows 2000/XP/2003/Vista

The HTTP management software (Archttp) runs as a service or daemon, and have it automatically start the proxy for all controllers found. This way the controller can be managed remotely without having to sign in the server. The HTTP management software (Archttp) also has integrated the email notification and SNMP Extension Agent. The email notification can be configured in local or remote standard web browser.

### **Note:**

If your controllers have onboard LAN port, you do not need to install Archttp proxy server, you can use McRAID Storage Manager directly.

# ARCHTTP PROXY SERVER INSTALLATION

## 5.1 For Windows

You must have administrative level permissions to install SAS RAID software. This procedure assumes that the SAS RAID hardware and Windows are installed and operational in your system. Screen captures in this section are taken from a Windows XP installation. If you are running another version of Windows, your installation screen may look different, but the ArchHttp proxy server installation is essentially the same.

1. Insert the RAID controller software CD in the CD-ROM drive.
2. Run the setup.exe file that resides at: <CD-ROM>\PACKAGES\Windows\http\setup.exe on the CD-ROM.
3. The screen shows "Preparing to Install".



Follow the on-screen prompts to complete ArchHttp proxy server software installation.

A program bar appears that measures the progress of the ArchHttp proxy server setup. When this screen completes, you have completed the ArchHttp proxy server software setup.

4. After a successful installation, the "Setup Complete" dialog box is displayed.



Click the "Finish" button to complete the installation.

# ARCHTTP PROXY SERVER INSTALLATION

Click on the "Start" button in the Windows task bar and then click "Program", select the "McRAID" and run " ArchHttp proxy server". The ArchHttp dialog box appears.

1. When you select "Controller#01(PCI)" then click "Start" button. Then web browser appears.
2. If you select "Cfg Assistant" then click "Start" button. The "ArchHttp Configuration" appears. (Please refer to section 5.6 ArchHttp Configuration)

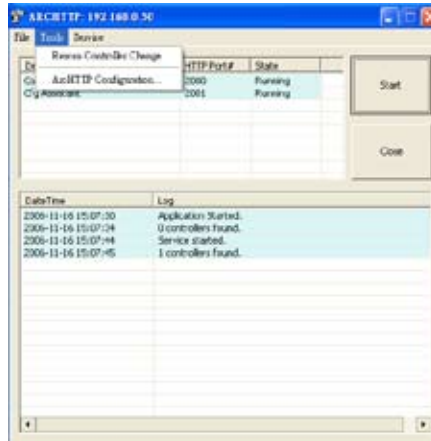

## 5.2 For Linux

You should have administrative level permissions to install SATA RAID software. This procedure assumes that the SATA RAID hardware and Linux are installed and operational in your system. The following details the Linux installation procedure of the SATA RAID controller software.

The ArchHttp proxy server is provided on the software CD delivered with SATA card or download from the [www.areca.com.tw](http://www.areca.com.tw). The firmware embedded McRAID storage manager can configure and monitor the SATA RAID controller via ArchHttp Proxy Server.

1. Login as root. Copy the ArchHttp file to a local directory.
  - (1). Insert the SATA RAID controller CD in the CD-ROM drive.
  - (2). Copy <CD-ROM>\PACKAGES\Mac\http directory to local (Ex:/

# ARCHTTP PROXY SERVER INSTALLATION

---

usr/local/sbin). Or

(1). Download from the [www.areca.com.tw](http://www.areca.com.tw) or from the email attachment.

2. You must have administrative level permissions to install SATA RAID controller ArchHttp software. This procedure assumes that the SATA RAID hardware and driver are installed and operational in your system.

The following details are the installation procedure of the SATA RAID controller for Mac ArchHttp software.

(1).Run the Archhttp proxy server by using the following command:

Usage: ./archhttp32 (TCP\_PORT) or ./archhttp64 (TCP\_PORT). It depends on your OS version.

Parameters: TCP\_PORT value= 1~65535 (If TCP\_PORT assigned, Archhttp will start from this port. Otherwise, it will use the setting in the archhttp.srv.conf or default 81). This is the port address assigning for the first adapter.

Such as: archhttp64 1553

(2). Archhttp server console started, Controller card detected then ArchHttp proxy server screen appears.

Copyright (c) 2004 Areca, Inc. All Rights Reserved.  
Areca HTTP proxy server V1.80.240 for Areca RAID controllers.

Controller(s) list

-----  
Controller[1](PCI) : Listen to port[1553].  
Cfg Assistant : Listen to port[1554].  
Binding IP:[0.0.0.0]  
Note: IP[0.0.0.0] stands for any ip bound to this host.  
-----

```
#####  
Press CTRL-C to exit program!!  
#####  
Controller [1] Http: New client [9] accepted  
Controller [1] Http: New Recv 243 bytes  
Controller [1] Http: Send [174] bytes back to the client
```

# ARCHTTP PROXY SERVER INSTALLATION

---

(2). If you need the “Cfg Assistant”, please refer to section 5.6 ArchHttp Configuration.

3. See the next chapter detailing the McRAID Storage Manager to customize your RAID volume set.

## **For Mozilla user:**

Because our management need Java support, so user may need upgrade to version 1.6 or later.

## **5.3 For FreeBSD**

You must have administrative level permissions to install SAS RAID software. This procedure assumes that the SAS RAID hardware and FreeBSD are installed and operational in your system.

The following details the FreeBSD installation procedure of the SAS RAID controller software.

1. Insert the RAID controller software CD in the CD-ROM drive.
2. Copy <CD-ROM>\PACKAGES\FreeBSD\http directory to local  
The next following step is the same with Linux. Please see section 5.2 For Linux.

## **5.4 For Solaris 10 X86**

Please refer to the “readme.txt” file on the software CD or website: <http://www.areca.com.tw>. The next step is the same with Linux.

Please see section 5.2 For Linux.

## **5.5 For Mac OS 10.X**

The ArchHttp proxy server is provided on the software CD delivered with SATA card or download from the [www.areca.com.tw](http://www.areca.com.tw). The firmware embedded McRAID storage manager can configure and monitor the SATA RAID controller via ArchHttp proxy server. The Archhttp proxy server for Mac, please reference Chapter 4.6 Driver Installation for Mac 10.x or refer to the the Mac\_manual\_XXXX.pdf that resides at CD <CD-ROM>\DOCS directory. You can install driver, archhttp64 and arc-cli from software CD < CD >\package\ Mac OS directory at the same time.

# ARCHTTP PROXY SERVER INSTALLATION

## 5.6 ArcHttp Configuration

The ArcHttp proxy server will automatically assign one additional port for setup its configuration. If you want to change the "archttpsrv.conf" setting up of ArcHttp proxy server configuration, for example: General Configuration, Mail Configuration, and SNMP Configuration, please start web browser `http://localhost: Cfg Assistant`. Such as `http://localhost: 82`. The port number for ArcHttp proxy server configuration is McRAID storage manager port number plus 1.

The ArcHttp configuration starts as following:

- **General Configuration:**



Binding IP: Restrict ArcHttp proxy server to bind only single interface (If more than one physical network in the server).

HTTP Port#: Value 1~65535

Display HTTP Connection Information To Console: Select "Yes" to show Http send bytes and receive bytes information in the console.

Scanning PCI Device: Select "Yes" for ARC-1XXX series controller

Scanning RS-232 Device: No

Scanning Inband Device: No

- **Mail (Alert by Mail) Configuration:**

To enable the controller to send the email function, you need to configure the SMTP function on the ArcHttp software. To enable the RAID controller email sending function, click on the "Mail Configuration" link. The "SMTP Server Configurations" menu will show as following:

# ARCHTTP PROXY SERVER INSTALLATION

When you open the mail configuration page, you will see following settings:

## SMTP Server Configuration:

SMTP server IP Address: Enter the SMTP server IP address which is not MCRAID manager IP.Ex: 192.168.0.2

## Mail Address Configurations:

Sender Name: Enter the sender name that will be shown in the outgoing mail.Ex: RaidController\_1  
Mail address: Enter the sender email that will be shown in the outgoing mail, but don't type IP to replace domain name. Ex: RaidController\_1@areca.com.tw

Account: Enter the valid account if your SMTP mail server need authentication.

Password: Enter the valid password if your SMTP mail server need authentication.

MailTo Name: Enter the alert receiver name that will be shown in the outgoing mail.

Mail Address: Enter the alert receiver mail address  
Ex: admin@areca.com.tw

## Event Notification Configurations:

According to your requirement, set the corresponding event level :

# ARCHTTP PROXY SERVER INSTALLATION

Disable Event Notification: No event notification will be sent.  
Urgent Error Notification: Send only urgent event  
Serious Error Notification: Send urgent and serious event  
Warning Error Notification: Send urgent, serious and warning Event  
Information Notification: Send all event  
Notification For No Event: Notify user if no event occurs within 24 hours.

## ● SNMP Traps Configuration:

To enable the controller to send the SNMP traps to client SNMP manager, such as Net-SNMP manager, you need to configure the SNMP function on the ArchHttp proxy server software. To enable the RAID controller SNMP traps sending function, click on the "SNMP Configuration" link. The "SNMP Traps Configurations" menu will show as following:

The screenshot shows the 'ARCHTTP Configurations' web interface. On the left is a navigation menu with links for 'General Configuration', 'Mib Configuration', and 'SNMP Trap Configuration'. The main content area is titled 'SNMP Trap Configurations' and contains several sections:

- SNMP Trap Configurations:** A table with three rows for 'SNMP Trap ID Address #1', 'SNMP Trap ID Address #2', and 'SNMP Trap ID Address #3'. Each row has columns for 'IP', 'Port', 'ID', 'Type', and 'Send To'. The first row is populated with '192.168.1.1', '161', '1', 'Trap', and 'Send To'.
- SNMP System Configurations:** A 'Community' field with the value 'public'.
- SNMP Trap Notifications Configurations:** A list of checkboxes for various event types, each with a corresponding 'Send To' field:
  - Enable Error Notification (Send To: Send Notifications With Error)
  - Urgent Error Notification (Send To: Send Only Urgent Error)
  - Serious Error Notification (Send To: Send Urgent And Serious Error)
  - Warning Error Notification (Send To: Send Urgent, Serious And Warning Error)
  - Information Notification (Send To: Send All Error)

At the bottom, there are 'Cancel' and 'Save' buttons.

## SNMP Trap Configurations

Enter the SNMP trap IP address.

## SNMP System Configurations

Community name acts as a password to screen accesses to the SNMP agent of a particular network device. Type the community names of the SNMP agent in this field. Before access is granted to a request station, this station must incorporate a valid community name into its request; otherwise, the SNMP agent will deny access to the system. Most network devices use "public" as default of their community names. This value is case-sensitive.

# ARCHTTP PROXY SERVER INSTALLATION

---

## **SNMP Trap Notification Configurations**

Before the client side manager application accepts the SAS RAID controller traps, it is necessary to integrate the MIB into the management application's database of events and status indicator codes. This process is known as compiling the MIB into the application. This process is highly vendor-specific and should be well-covered in the User's Guide of your SNMP application. Ensure the compilation process successfully integrates the contents of the ARECARAID.MIB file into the traps database.

### **Note:**

Event Notification Table refer to Appendix D.  
After you confirm and submit configurations, you can use "Generate Test Event" feature to make sure these settings are correct.

# WEB BROWSER-BASED CONFIGURATION

---

## 6. Web Browser-based Configuration

Before using the firmware-based browser McRAID storage manager, do the initial setup and installation of this product. If you need to boot up the operating system from a RAID volume set, you must first create a RAID volume by using McBIOS RAID manager. Please refer to section 3.3 Using Quick Volume /Raid Setup Configuration for information on creating this initial volume set.

The McRAID storage manager is firmware-based utility, which is accessible via the web browser installed on your operating system. The web browser-based McRAID storage manager is a HTML-based application, which utilizes the browser (IE, Netscape and Mozilla etc) installed on your monitor station.

It can be accessed through the In-Band PCIe bus or Out-of-Band LAN port. The In-Band method via archttp proxy server to launch the web browser-based McRAID storage manager. The firmware-embedded web browser-based McRAID storage manager allows local or remote to access it from any standard internet browser via a LAN or WAN with no software or patches required. The firmware contains SMTP manager monitors all system events and user can select either single or multiple user notifications to be sent via LAN with "Plain English" e-mails. The firmware-embedded SNMP agent allows remote to monitor events via LAN with no SNMP agent required.

- Create raid set
- Expand raid set
- Define volume set
- Add physical drive
- Modify volume set
- Modify RAID level/stripe size
- Define pass-through disk drives
- Modify system function
- Update firmware
- Designate drives as hot spares

### 6.1 Start-up McRAID Storage Manager

With the McRAID storage manager, you can locally manage a system containing a SAS RAID controller that has Windows, Linux

# WEB BROWSER-BASED CONFIGURATION

or more and a supported browser. A locally managed system requires all of the following components:

- A supported Web browser, which should already be installed on the system.
- Install ArchHttp proxy server on the SAS RAID system. (Refer to Chapter 5, ArchHttp Proxy Server Installation)
- Remote and managed systems must have a TCP/IP connection.

## • Start-up McRAID Storage Manager from Windows Local Administration

Screen captures in this section are taken from a Windows XP installation. If you are running another version of Windows, your screens may look different, but the ArchHttp proxy server installation is essentially the same.

1. To start the McRAID storage manager for browser-based management, selecting "Controller#01(PCI)" and then click the "Start" button.

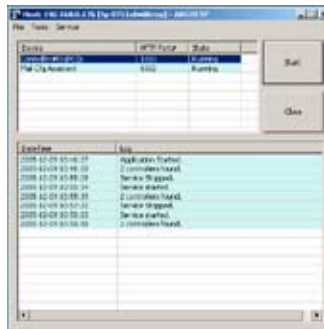

The "Enter Network Password" dialog screen appears, type the User Name and Password. The RAID controller default User Name is "admin" and the Password is "0000". After entering the user name and password, press **Enter** key to access the McRAID storage manager.

# WEB BROWSER-BASED CONFIGURATION

---



## ● Start-up McRAID Storage Manager from Linux/FreeBSD/Solaris/Mac Local Administration

To configure the internal SAS RAID controller. You need to know its IP address. You can find the IP address assigned by the Archttp proxy server installation: Binding IP:[X.X.X.X] and controller listen port.

(1). Launch your McRAID storage manager by entering `http://[Computer IP Address]:[Port Number]` in the web browser.

(2). When connection is established, the "System Login" screen appears. The SAS RAID controller default User Name is "admin" and the Password is "0000"

## ● Start-up McRAID Storage Manager Through Ethernet Port (Out-of-Band)

Areca now offers an alternative means of communication for the PCIe RAID controller – Web browser-based McRAID storage manager program. User can access the built-in configuration without needing system starting up running the Archttp proxy sever. The web browser-based McRAID storage manager program is an HTML-based application, which utilizes the browser installed on your remote system.

To ensure proper communications between the PCIe RAID controller and web browser-based McRAID storage manager, Please connect the RAID controller LAN port to any LAN switch port.

The controller has embedded the TCP/IP & Web Browser-based RAID manager in the firmware. User can remote manage the RAID controller without adding any user specific software (platform independent) via standard web browsers directly connected

# WEB BROWSER-BASED CONFIGURATION

to the 10/100 RJ45 LAN port.

To configure RAID controller on a remote machine, you need to know its IP address. The IP address will default show in McBIOS RAID manager of "Ethernet Configuration" or "System Information" option. Launch your firmware-embedded TCP/IP & web browser-based McRAID storage manager by entering `http://[IP Address]` in the web browser.

## Note:

You can find controller Ethernet port IP address in McBIOS RAID manager "System Information" option.

## 6.2 SAS RAID controller McRAID Storage Manager

The McRAID storage manager initial start-up screen displays the current configuration of your SAS RAID controller. It displays the "Raid Set List", "Volume Set List", and "Physical Disk List". The RAID set information, volume set information, and drive information can also be viewed by clicking on the "RAID Set Hierarchy" screen. The current configuration can also be viewed by clicking on "RAID Set Hierarchy" in the main menu.

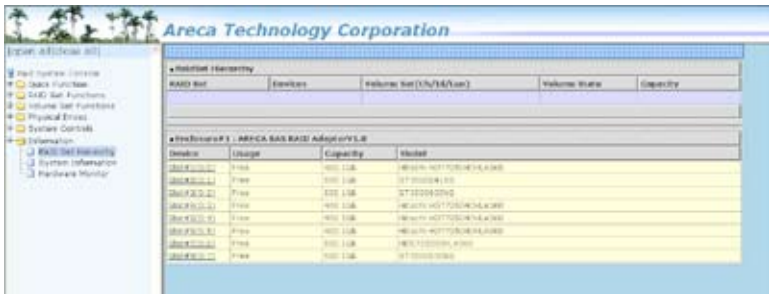

To display RAID set information, move the mouse cursor to the desired RAID set number, then click it. The RAID set information will appear. To display volume set information, move the mouse cursor to the desired volume set number, then click it. The volume set information will display. To display drive information, move the mouse cursor to the desired physical drive number, then click it. The drive information will display.

# WEB BROWSER-BASED CONFIGURATION

## 6.3 Main Menu

The main menu shows all available functions, accessible by clicking on the appropriate link.

Individual Category	Description
Quick Function	Create a default configuration, which is based on the number of physical disks installed; it can modify the volume set Capacity, Raid Level, and Stripe Size.
Raid Set Functions	Create a customized RAID set.
Volume Set Functions	Create customized volume sets and modify the existed volume sets parameter.
Physical Drives	Create pass through disks and modify the existing pass through drives parameters. Also provides the function to identify disk drives (blinking fault LED).
System Controls	Setting the RAID system configuration.
Information	Viewing the controller information. The Raid Set Hierarchy can be viewed through the "Raid Set Hierarchy" item.

## 6.4 Quick Function



The number of physical drives in the SAS RAID controller determines the RAID levels that can be implemented with the RAID set. You can create a RAID set associated with exactly one volume set. The user can change the RAID Level, Capacity, Initialization Mode and Stripe Size. A hot spare option is also created, depending on the exist configuration. Click the "Confirm The Operation" check box and click on the "Submit" button in the "Quick Create" screen, the RAID set and volume set will start to initialize.

# WEB BROWSER-BASED CONFIGURATION

## Note:

In "Quick Create", your volume set is automatically configured based on the number of disks in your system. Use the "Raid Set Functions" and "Volume Set Functions" if you prefer to customize your volume set, or RAID 30/50/60 volume set.

## 6.5 Raid Set Functions

Use the "Raid Set Function" and "Volume Set Function" if you prefer to customize your volume set. Manual configuration can provide full control of the RAID set settings, but it will take longer to complete than the "Quick Volume/Raid Setup" configuration. Select the "Raid Set Function" to manually configure the RAID set for the first time or delete and reconfigure existing RAID sets. (A RAID set is a group of disks containing one or more volume sets.)

### 6.5.1 Create Raid Set

To create a RAID set, click on the "Create Raid Set" link. A "Select The Drive For RAID Set" screen is displayed showing the drive(s) connected to the current controller and enclosures. Click on the selected physical drives within the current RAID set. Enter 1 to 15 alphanumeric characters to define a unique identifier for a RAID set. The default RAID set name will always appear as "Raid Set #".

Click the "Confirm The Operation" check box and click on the "Submit" button on the screen; the RAID set will start to initialize. If you have available disk member, you can repeat above procedures to define another RAID sets.



# WEB BROWSER-BASED CONFIGURATION

## Note:

To create RAID 30/50/60 volume, you need create multiple RAID sets first with the same disk members on each RAID set. The max no. disk drives per volume set: 8

## 6.5.2 Delete Raid Set

To delete a RAID set, click on the "Deleted Raid Set" link. A "Select The RAID Set To Delete" screen is displayed showing all exist RAID sets in the current controller. Click the RAID set number which you want to delete in the select column on the delete screen. Then, click the "Confirm The Operation" check box and click on the "Submit" button in the screen to delete it. The volume sets included in the "Delete RAID Set". It will be deleted by this action. But for the Raid 30/50/60, you need to delete the volume belonging to those RAID sets.



## 6.5.3 Expand Raid Set

Instead of deleting a RAID set and recreating it with additional disk drives, the "Expand Raid Set" function allows the users to add disk drives to the RAID set that have already been created.

To expand a RAID set:

Select the "Expand Raid Set" option. If there is an available disk, then the "Select SATA Drives For Raid Set Expansion" screen appears.

Select the target RAID set by clicking on the appropriate radio button. Select the target disk by clicking on the appropriate check box.

# WEB BROWSER-BASED CONFIGURATION



Press the **Yes** key to start the expansion on the RAID set. The new additional capacity can be utilized by one or more volume sets. The volume sets associated with this RAID set appear for you to have chance to modify RAID level or stripe size. Follow the instruction presented in the "Modify Volume Set " to modify the volume sets; operation system specific utilities may be required to expand operating system partitions.

## Note:

1. Once the "Expand Raid Set" process has started, user can not stop it. The process must be completed.
2. If a disk drive fails during raid set expansion and a hot spare is available, an auto rebuild operation will occur after the RAID set expansion completes.
3. RAID 30/50/60 does n't support the 'Expand Raid Set'.

## 6.5.4 Activate Incomplete Raid Set

If one of the disk drives is removed in power off state, the RAID set state will change to "Incomplete State". If the user wants to continue to operate the controller without power-off the SAS RAID controller, the user can use the "Activate Incomplete Raid Set" option to active the RAID set. After the user completes this function, the Raid State will change to "Degraded Mode" and start to work.



# WEB BROWSER-BASED CONFIGURATION

To activate the incomplete the RAID set, click on the "Activate Raid Set" link. A "Select The RAID SET To Activate" screen is displayed showing all RAID sets existing on the current controller. Click the RAID set number to activate in the select column. Click on the "Submit" button on the screen to activate the RAID set that had a disk removed (or failed) in the power off state. The SAS RAID controller will continue to work in degraded mode.

## 6.5.5 Create Hot Spare



When you choose the "Create Hot Spare" option in the "Raid Set Function", all unused physical devices connected to the current controller appear. Select the target disk by clicking on the appropriate check box. Click the "Confirm The Operation" check box and click the "Submit" button in the screen to create the hot spares. The "Create Hot Spare" option gives you the ability to define a global hot spare.

## 6.5.6 Delete Hot Spare

Select the target hot spare disk to delete by clicking on the appropriate check box. Click the "Confirm The Operation" check box and click the "Submit" button on the screen to delete the hot spares.

# WEB BROWSER-BASED CONFIGURATION

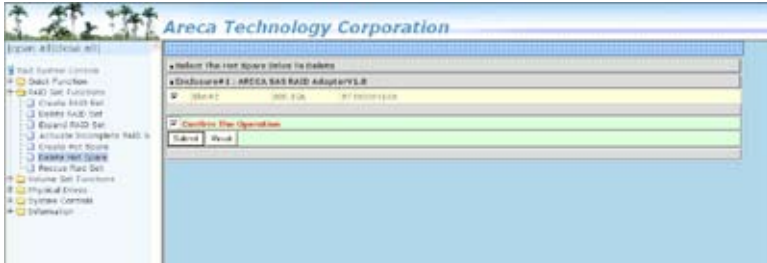

## 6.5.7 Rescue Raid Set

When the system is powered off in the RAID set update/creation period, the configuration possibly could disappear due to this abnormal condition. The "RESCUE" function can recover the missing RAID set information. The RAID controller uses the time as the RAID set signature. The RAID set may have different time after the RAID set is recovered. The "SIGANT" function can regenerate the signature for the RAID set.



## 6.5.8 Offline Raid Set

This function is for customer being able to unmount and remount a multi-disk volume. All Hdds of the selected RAID set will be put into offline state, spun down and fault LED in fast blinking mode. User can remove those Hdds and insert new Hdds on those empty slots without needing power down the controller.

## 6.6 Volume Set Functions

A volume set is seen by the host system as a single logical device. It is organized in a RAID level with one or more physical disks. RAID level refers to the level of data performance and protection of a volume set. A volume set capacity can consume all or a portion

# WEB BROWSER-BASED CONFIGURATION

of the disk capacity available in a RAID set. Multiple volume sets can exist on a group of disks in a RAID set. Additional volume sets created in a specified RAID set will reside on all the physical disks in the RAID set. Thus each volume set on the RAID set will have its data spread evenly across all the disks in the RAID set.

The following is the volume set features for the SAS RAID controller.

1. Volume sets of different RAID levels may coexist on the same RAID set.
2. Up to 128 volume sets can be created in a RAID set.
3. The maximum addressable size of a single volume set is not limited to two TB, because the controller is capable of 64-bit LBA mode. However the operating system itself may not be capable of addressing more than two TB.

**See Areca website [ftp://ftp.areca.com.tw/RaidCards/Documents/Manual\\_Spec/Over2TB\\_050721.ZIP](ftp://ftp.areca.com.tw/RaidCards/Documents/Manual_Spec/Over2TB_050721.ZIP) file for details.**

## 6.6.1 Create Volume Set (0/1/10/3/5/6)

To create volume set from RAID set system, move the cursor bar to the main menu and click on the "Create Volume Set" link. The "Select The Raid Set To Create On It" screen will show all RAID set number. Tick on a RAID set number that you want to create and then click on the "Submit" button.

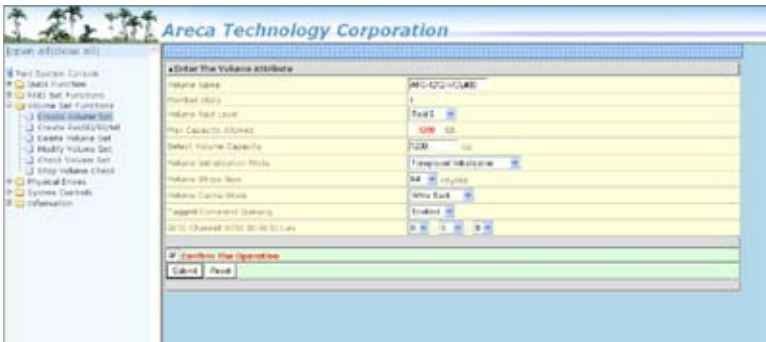

# WEB BROWSER-BASED CONFIGURATION

---

The new create volume set attribute allows user to select the Volume Name, RAID Level, Capacity, Greater Two TB Volume Support, Initialization Mode, Strip Size, Cache Mode, Tagged Command Queuing, SCSI Channel/SCSI ID/SCSI Lun.

- **Volume Name**

The default volume name will always appear as "ARC-1212-VOL". You can rename the volume set providing it does not exceed the 15 characters limit.

- **Volume Raid Level**

Set the RAID level for the volume set. Highlight the desired RAID Level and press **Enter** key.

The available RAID levels for the current volume set are displayed. Select a RAID level and press **Enter** key to confirm.

- **Capacity**

The maximum volume size is the default initial setting. Enter the appropriate volume size to fit your application.

- **Greater Two TB Volume Support**

If volume capacity will exceed Two TB, controller will show the "Greater Two TB Volume Support" sub-menu. Greater Two TB Volume Support option: No and 64bit LBA.

For more details please download PDF file from [ftp://ftp.areca.com.tw/RaidCards/Documents/Manual\\_Spec/Over2TB\\_050721.zip](ftp://ftp.areca.com.tw/RaidCards/Documents/Manual_Spec/Over2TB_050721.zip)

- **Initialization Mode**

Press **Enter** key to define "Background Initialization", "Foreground Initialization" or "No Init (To Rescue Volume)". When "Background Initialization", the initialization proceeds as a background task, the volume set is fully accessible for system reads and writes. The operating system can instantly access to the newly created arrays without requiring a reboot and waiting the initialization complete. When "Foreground Initialization", the initialization proceeds must be completed before the volume set ready for system accesses. There is no initialization happed when you select "No Init" option. "No Init" is for customer to rescue volume without losing data in the disk.

# WEB BROWSER-BASED CONFIGURATION

---

- **Strip Size**

This parameter sets the size of the stripe written to each disk in a RAID 0, 1, 10, 5, 6, 50 or 60 logical drive. You can set the stripe size to 4 KB, 8 KB, 16 KB, 32 KB, 64 KB, or 128 KB. A larger stripe size produces better read performance, especially if your computer does mostly sequential reads. However, if you are sure that your computer does random reads more often, select a smaller stripe size.

**Note:**

RAID level 3 can't modify the cache strip size.

- **Cache Mode**

The SAS RAID controller supports "Write Through" and "Write Back" cache.

- **Tagged Command Queuing**

The "Enabled" option is useful for enhancing overall system performance under multi-tasking operating systems. The Command Tag (Drive Channel) function controls the SAS command tag queuing support for each drive channel. This function should normally remain "Enabled". "Disabled" this function only when using SAS drives that do not support command tag queuing.

- **SCSI Channel/SCSI ID/SCSI Lun**

**SCSI Channel:** The SAS RAID controller function is simulated as an external SCSI RAID controller. The host bus is represented as a SCSI channel. Choose the SCSI Channel.

**SCSI ID:** Each SCSI device attached to the SCSI card, as well as the card itself, must be assigned a unique SCSI ID number. A SCSI channel can connect up to 15 devices. The SAS RAID controller is a large SCSI device. Assign an ID from a list of SCSI IDs.

**SCSI LUN:** Each SCSI ID can support up to 8 LUNs. Most SAS controllers treat each LUN like a SAS disk.

# WEB BROWSER-BASED CONFIGURATION

## 6.6.2 Create Raid30/50/60 (Volume Set 30/50/60)

To create 30/50/60 volume set from RAID set group, move the cursor bar to the main menu and click on the "Create Raid30/50/60" link. The "Select The Raid Set To Create Volume On It" screen will show all RAID set number. Tick on the RAID set numbers (same disk No per RAID set) that you want to create and then click on the "Submit" button.

The new create volume set attribute allows user to select the Volume Name, RAID Level, Capacity, Greater Two TB Volume Support, Initialization Mode, Strip Size, Cache Mode, Tagged Command Queuing, SCSI Channel/SCSI ID/SCSI Lun. Please refer to above section for details description of each item.

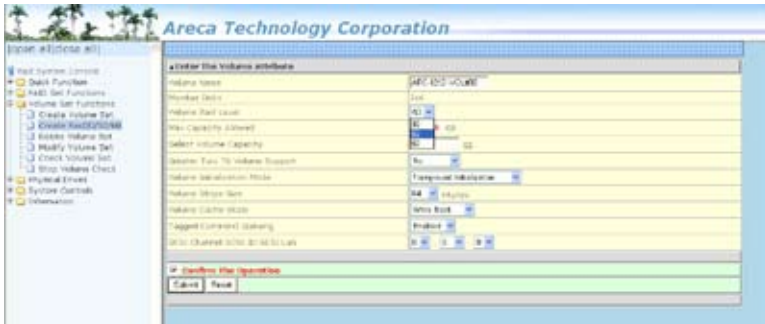

### Note:

ARC-1212 4-port SAS/SATA controller does not support Raid 30/50/60. There is no action on this configuration when it is appeared. RAID level 30, 50 and 60 can support up to eight sub-volumes (RAID set), but it can not support expansion and migration.

## 6.6.3 Delete Volume Set

To delete a volume from RAID set, move the cursor bar to the main menu and click on the "Delete Volume Set" link. The "Select The Raid Set To Delete" screen will show all RAID set numbers. Click a RAID set number and the "Confirm The Operation" check box and then click the "Submit" button to show all volume set

# WEB BROWSER-BASED CONFIGURATION

items in the selected RAID set. Click a volume set number and the “Confirm The Operation” check box and then click the “Submit” button to delete the volume set.



## 6.6.4 Modify Volume Set

To modify a volume set from a RAID set:

- (1). Click on the “Modify Volume Set” link.
- (2). Click the volume set check box from the list that you wish to modify. Click the “Submit” button. The following screen appears.

Use this option to modify the volume set configuration. To modify volume set attributes, move the cursor bar to the volume set attribute menu and click it. The “Enter The Volume Attribute” screen appears. Move the cursor to an attribute item and then click the attribute to modify the value. After you complete the modification, click the “Confirm The Operation” check box and click the “Submit” button to complete the action. The user can only modify the last volume set capacity.



# WEB BROWSER-BASED CONFIGURATION

---

## 6.6.4.1 Volume Growth

Use "Expand RAID Set" function to add disk to a RAID set. The additional capacity can be used to enlarge the last volume set size or to create another volume set. The "Modify Volume Set" function can support the "Volume Modification" function. To expand the last volume set capacity, move the cursor bar to the "Capacity" item and enter the capacity size. When finished the above action, press the **ESC** key and select the **Yes** option to complete the action. The last volume set starts to expand its capacity.

### To expand an existing volume noticed:

- Only the last volume can expand capacity.
- When expand volume capacity, you can't modify stripe size or modify RAID level simultaneously.
- You can expand volume capacity, but can't reduce volume capacity size.
- After volume expansion, the volume capacity can't be decreased.

### For greater 2TB expansion:

- If your system installed in the volume, don't expand the volume capacity greater 2TB, currently OS can't support boot up from a greater 2TB capacity device.
- Expand over 2TB used LBA64 mode. Please make sure your OS supports LBA64 before expand it.

## 6.6.4.2 Volume Set Migration

Migrating occurs when a volume set is migrating from one RAID level to another, when a volume set strip size changes, or when a disk is added to a RAID set. Migration state is displayed in the volume state area of the "Volume Set Information" screen.

# WEB BROWSER-BASED CONFIGURATION

## Note:

If the volume is RAID level 30, 50, or 60, you can not change the volume to another RAID level. If the volume is RAID level 0, 1, 10, 3, 5, or 6, you can not change the volume to RAID level 30, 50, or 60.

## 6.6.5 Check Volume Set

The screenshot shows the 'Check Volume Set' page in the Areca Technology Corporation web interface. The left sidebar contains a navigation menu with 'Check Volume Set' selected. The main content area is divided into two sections:

- RAID Set Information:** A table listing RAID sets.
- RAID Set #1: ARE CA 648 RAID Adpt 0FF LB:** A table listing individual disks in the RAID set.

RAID Set #	RAID Level	Volume Set (Dr/10/5/6)	Volume State	Capacity
Set # 01	RAID0/F3	ARE_CA648_RA0_001	Normal	12,000
Set # 02	RAID0/F3	ARE_CA648_RA0_002	Normal	12,000

Index	Usage	Capacity	Model
00000001	RAID Set # 01	100,000	ARE-CA648RA0-001
00000002	RAID Set # 01	100,000	ARE-CA648RA0-002
00000003	RAID Set # 01	100,000	ARE-CA648RA0-003
00000004	RAID Set # 01	100,000	ARE-CA648RA0-004
00000005	RAID Set # 01	100,000	ARE-CA648RA0-005
00000006	RAID Set # 01	100,000	ARE-CA648RA0-006
00000007	RAID Set # 01	100,000	ARE-CA648RA0-007
00000008	RAID Set # 01	100,000	ARE-CA648RA0-008
00000009	RAID Set # 01	100,000	ARE-CA648RA0-009
00000010	RAID Set # 01	100,000	ARE-CA648RA0-010
00000011	RAID Set # 01	100,000	ARE-CA648RA0-011
00000012	RAID Set # 01	100,000	ARE-CA648RA0-012

To check a volume set from a RAID set:

The screenshot shows the 'Check Volume Set' page in the Areca Technology Corporation web interface. The left sidebar contains a navigation menu with 'Check Volume Set' selected. The main content area displays the configuration details for a volume set:

- Volume Name:** ARE-CA648-001
- Max Capacity:** 120,000
- Volume Capacity:** 120,000
- Volume Information Mode:** RAID0
- Volume RAID Level:** RAID 0
- Volume Drive Size:** 120,000
- Volume Drive Mode:** Write Back
- Tagged Command Security:** Enabled
- RAID Channel:** 00000001-00000012

At the bottom, there are buttons for 'Exit the Operation' and 'Submit / Next'.

# WEB BROWSER-BASED CONFIGURATION

- (1). Click on the "Check Volume Set" link.
- (2). Click on the volume set from the list that you wish to check. Tick on "Confirm The Operation" and click on the "Submit" button. Use this option to verify the correctness of the redundant data in a volume set. For example, in a system with dedicated parity, volume set check means computing the parity of the data disk drives and comparing the results to the contents of the dedicated parity disk drive. The checking percentage can also be viewed by clicking on "RAID Set Hierarchy" in the main menu.

## 6.6.6 Stop Volume Set Check

Use this option to stop the "Check Volume Set" function.

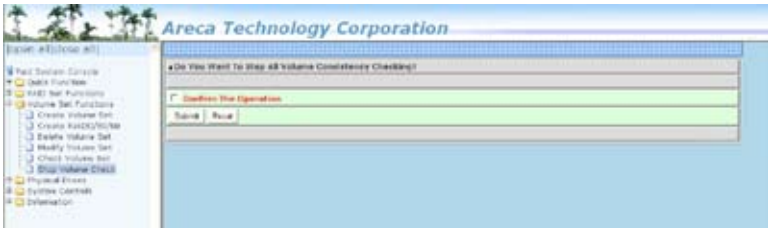

## 6.7 Physical Drive

Choose this option to select a physical disk from the main menu and then perform the operations listed below.

### 6.7.1 Create Pass-Through Disk

To create pass-through disk, move the mouse cursor to the main menu and click on the "Create Pass-Through" link. The "relative setting function" screen appears. A pass-through disk is not controlled by the SAS RAID controller firmware, it can't be a part of a volume set. The disk is available to the operating system as an individual disk. It is typically used on a system where the operating system is on a disk not controlled by the RAID firmware. The user can also select the Cache Mode, Tagged Command Queuing, SCSI channel/SCSI\_ID/SCSI\_LUN for this pass-through disk.



# WEB BROWSER-BASED CONFIGURATION

## 6.7.3 Delete Pass-Through Disk

To delete a pass-through drive from the pass-through drive pool, move the mouse cursor bar to the main menus and click the "Delete Pass Through" link. After you complete the selection, mark the check box for "Confirm The Operation" and click the "Submit" button to complete the delete action.



## 6.7.4 Identify Drive

To prevent removing the wrong drive, the selected disk fault LED indicator will light for physically locating the selected disk when the "Identify Selected Device" is selected.

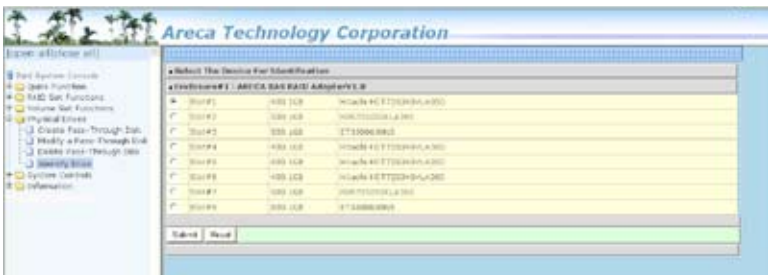

# WEB BROWSER-BASED CONFIGURATION

## 6.8 System Controls

### 6.8.1 System Config

To set the RAID system function, move the cursor to the main menu and click the "System Controls" link. The "Raid System Function" menu will show all items, then select the desired function.

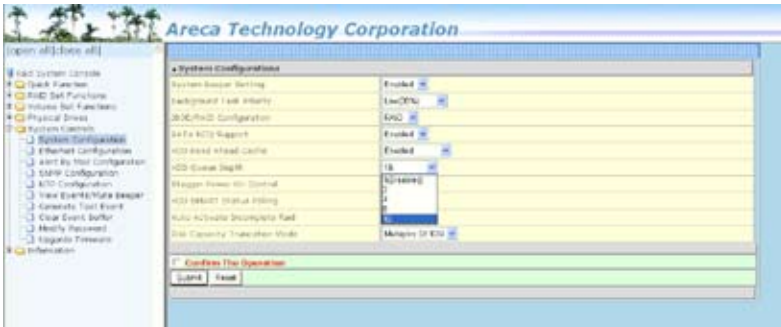

- **System Beep Setting**

The "System Beep Setting" function is used to "Disabled" or "Enabled" the SAS RAID controller alarm tone generator.

- **Background Task Priority**

The "Background Task Priority" is a relative indication of how much time the controller devotes to a rebuild operation. The SAS RAID controller allows the user to choose the rebuild priority (UltraLow, Low, Normal, High) to balance volume set access and rebuild tasks appropriately. For high array performance, specify a "Low" value.

- **JBOD/RAID Configuration**

JBOD is an acronym for "Just a Bunch Of Disk". A group of hard disks in a RAID box are not set up as any type of RAID configuration. All drives are available to the operating system as an individual disk. JBOD does not provide data redundancy. User needs to delete the RAID set, when you want to change the option from the RAID to the JBOD function.

# WEB BROWSER-BASED CONFIGURATION

---

- **HDD Read Ahead Cache**

Allow Read Ahead (Default: Enabled)—When Enabled, the drive's read ahead cache algorithm is used, providing maximum performance under most circumstances.

- **HDD Queue Depth**

This parameter is adjusted the queue depth capacity of NCQ (SATA HDD) or Tagged Command Queuing (SAS) which transmits multiple commands to a single target without waiting for the initial command to complete.

- **Stagger Power on**

In a PC system with only one or two drives, the power can supply enough power to spin up both drives simultaneously. But in systems with more than two drives, the startup current from spinning up the drives all at once can overload the power supply, causing damage to the power supply, disk drives and other system components. This damage can be avoided by allowing the host to stagger the spin-up of the drives. The SAS/SATA drives have support stagger spin-up capabilities to boost reliability. Stagger spin-up is a very useful feature for managing multiple disk drives in a storage subsystem. It gives the host the ability to spin up the disk drives sequentially or in groups, allowing the drives to come ready at the optimum time without straining the system power supply. Staggering drive spin-up in a multiple drive environment also avoids the extra cost of a power supply designed to meet short-term startup power demand as well as steady state conditions.

Areca RAID controller has included the option for customer to select the disk drives sequentially stagger power up value. The values can be selected from 0.4s to 6s per step which powers up one drive.

- **Auto Activate Incomplete Raid**

When some of the disk drives are removed in power off state or boot up stage, the RAID set state will change to "Incomplete State". But if a user wants to automatically continue to work while the SAS RAID controller is powered on, the user can set the "Auto Activate Incomplete Raid" option to enable. The RAID state will change to "Degraded Mode" while it powers on.

# WEB BROWSER-BASED CONFIGURATION

---

## ● Disk Capacity Truncation Mode

Areca RAID controllers use drive truncation so that drives from differing vendors are more likely to be able to be used as spares for each other. Drive truncation slightly decreases the usable capacity of a drive that is used in redundant units. The controller provides three truncation modes in the system configuration: **Multiples Of 10G**, **Multiples Of 1G**, and **Disabled**.

**Multiples Of 10G:** If you have 120 GB drives from different vendors; chances are that the capacity varies slightly. For example, one drive might be 123.5 GB, and the other 120 GB. Multiples Of 10G truncates the number under tens. This makes same capacity for both of these drives so that one could replace the other.

**Multiples Of 1G:** If you have 123 GB drives from different vendors; chances are that the capacity varies slightly. For example, one drive might be 123.5 GB, and the other 123.4 GB. Multiples Of 1G truncates the fractional part. This makes capacity for both of these drives so that one could replace the other.

**No Truncation:** It does not truncate the capacity.

## 6.8.2 Ethernet Configuration

Use this feature to set the controller Ethernet port configuration. A customer doesn't need to create a reserved space on the arrays before the Ethernet port and HTTP service are working. The firm-ware-embedded Web Browser-based RAID manager can access it from any standard internet browser or from any host computer either directly connected or via a LAN or WAN with no software or patches required.

DHCP (Dynamic Host Configuration Protocol) is a protocol that lets network administrators manage centrally and automate the assignment of IP (Internet Protocol) configurations on a computer network. When using the internet's set of protocols (TCP/IP), in order for a computer system to communicate to another computer system, it needs a unique IP address. Without DHCP, the IP address must be entered manually at each computer system. DHCP lets a network administrator supervise and distribute IP addresses from a central point. The purpose of DHCP is to provide the automatic (dynamic) allocation of IP client configurations for

# WEB BROWSER-BASED CONFIGURATION

a specific time period (called a lease period) and to eliminate the work necessary to administer a large IP network.

To configure the RAID controller Ethernet port, move the cursor bar to the main menu and click on the "System Controls" link. The "System Controls" menu will show all items. Move the cursor bar to the "Ethernet Configuration" item, then press **Enter** key to select the desired function.

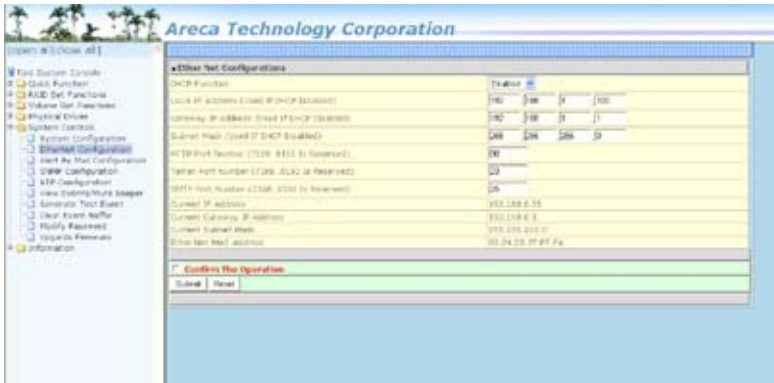

## 6.8.3 Alert By Mail Configuration

To configure the RAID controller e-mail function, move the cursor bar to the main menu and click on the "System Controls" link. The "System Controls" menu will show all items. Move the cursor bar to the "Alert By Mail Configuration" item, then select the desired function. This function can only be set via web-based configuration.

The firmware contains a SMTP manager monitoring all system events. Single or multiple user notifications can be sent via "Plain English" e-mails with no software required. (Please refer to section 5.6.2 of SMTP Sever Configuration, Mail Address Configuration and Event Notification Configuration)

# WEB BROWSER-BASED CONFIGURATION

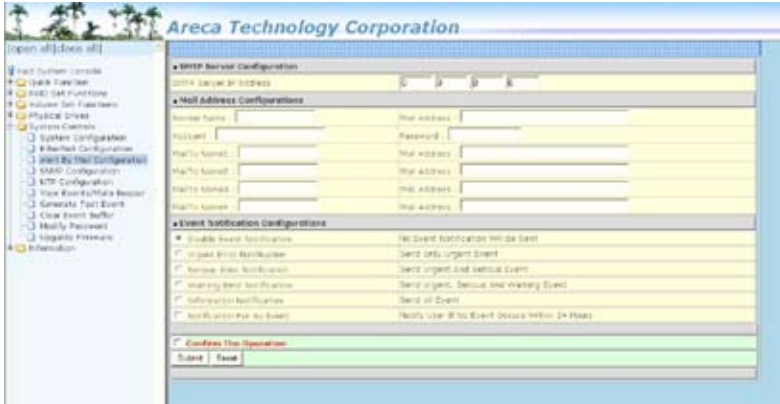

## 6.8.4 SNMP Configuration

To configure the RAID controller SNMP function, click on the "System Controls" link. The "System Controls" menu will show available items. Select the "SNMP Configuration" item. This function can only set via web-based configuration.

The firmware SNMP agent manager monitors all system events and the SNMP function becomes functional with no agent software required.

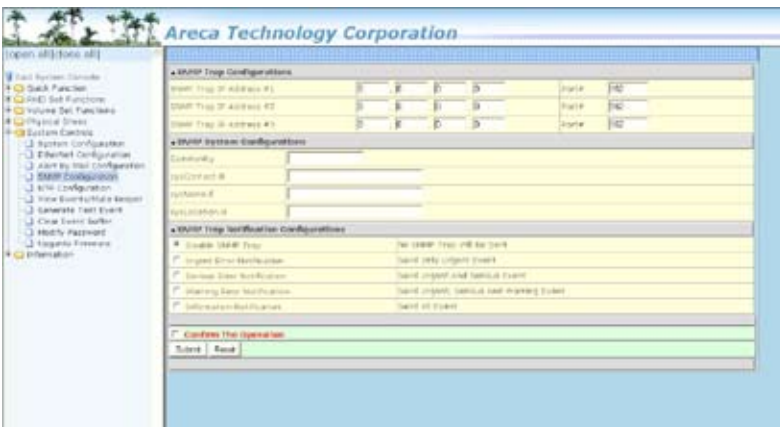

# WEB BROWSER-BASED CONFIGURATION

- **SNMP Trap Configurations**

Enter the SNMP Trap IP Address.

- **SNMP System Configurations**

About community, please refer to Appendix C of SNMP community name. The system Contact, Name and Location that will be shown in the outgoing SNMP trap.

- **SNMP Trap Notification Configurations**

Please refer to Appendix E of Event Notification Configurations.

## 6.8.5 NTP Configuration

The Network Time Protocol (NTP) is used to synchronize the time of a computer client or server to another server or reference time source, such as a radio or satellite receiver or modem. It provides accuracies typically within a millisecond on LANs and up to a few tens of milliseconds on WANs relative to Coordinated Universal Time (UTC) via a Global Positioning Service (GPS) receiver, for example:

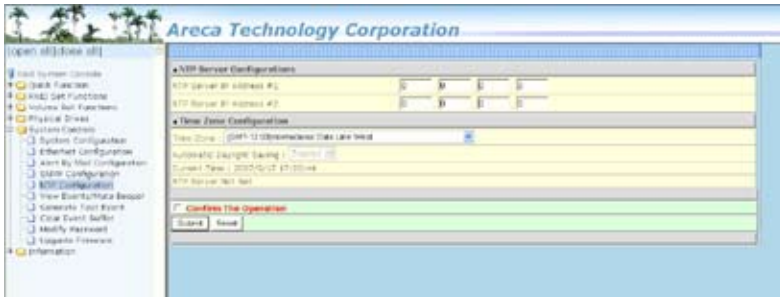

- **NTP Sever Address**

The most important factor in providing accurate, reliable time is the selection of NTP servers to be used in the configuration file. Typical NTP configurations utilize multiple redundant servers and diverse network paths in order to achieve high accuracy and reliability. Our NTP configuration supports two existing public NTP synchronization subnets.



# WEB BROWSER-BASED CONFIGURATION

Select this option to view the system events information: Timer, Device, Event type, Elapse Time and Errors. The RAID controller does not have a built-in real time clock. The time information is the relative time from the system time setting. The maximum event no. is 256 per controller.

## 6.8.7 Generate Test Event

Use this feature is generate events for testing purposes.



## 6.8.8 Clear Events Buffer

Use this feature to clear the entire events buffer information.

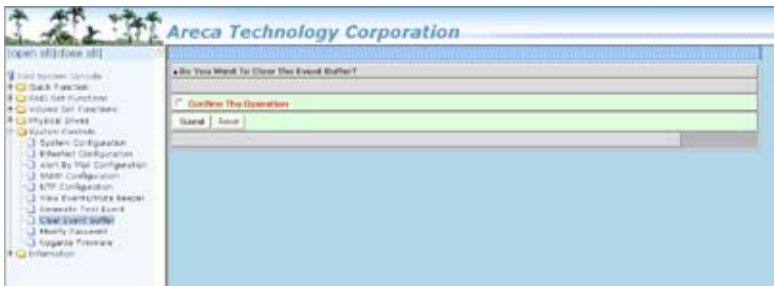

## 6.8.9 Modify Password

To set or change the SAS RAID controller password, select "System Controls" from the menu and click on the "Modify Password" link. The "Modify System Password" screen appears.

# WEB BROWSER-BASED CONFIGURATION



## The manufacture default password is set to 0000.

The password option allows user to set or clear the SAS RAID controller's password protection feature. Once the password has been set, the user can only monitor and configure the SAS RAID controller by providing the correct password. The password is used to protect the SAS RAID controller from unauthorized entry. The controller will check the password only when entering the main menu from the initial screen. The SAS RAID controller will automatically go back to the initial screen when it does not receive any command in 5 minutes. Do not use spaces when you enter the password, If spaces are used, it will lock out the user.

To disable the password, leave the fields blank. Once the user confirms the operation and clicks the "Submit" button, the existing password will be cleared. Then, no password checking will occur when entering the main menu from the starting screen.

## 6.8.10 Update Firmware

Please refer to the appendix A Upgrading Flash ROM Update Process



# WEB BROWSER-BASED CONFIGURATION

## 6.9 Information

### 6.9.1 Raid Set Hierarchy

Use this feature to view the SAS RAID controller current RAID set, current volume set and physical disk information. The volume state and capacity are also shown in this screen.

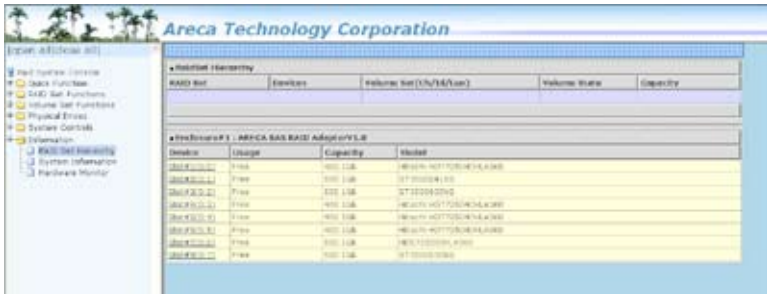

### 6.9.2 System Information

To view the SAS RAID controller's system information, move the mouse cursor to the main menu and click on the "System Information" link. The SAS RAID controller "RAID Subsystem Information" screen appears.

Use this feature to view the SAS RAID controller's system information. The controller name, controller firmware version, Boot ROM version, SAS firmware version, serial number, main processor, CPU data/instruction cache size, system memory size/speed and current IP address appear in this screen.



# WEB BROWSER-BASED CONFIGURATION

## 6.9.3 Hardware Monitor

The hardware monitor information of the enclosure attached in this controller is also shown on this screen.

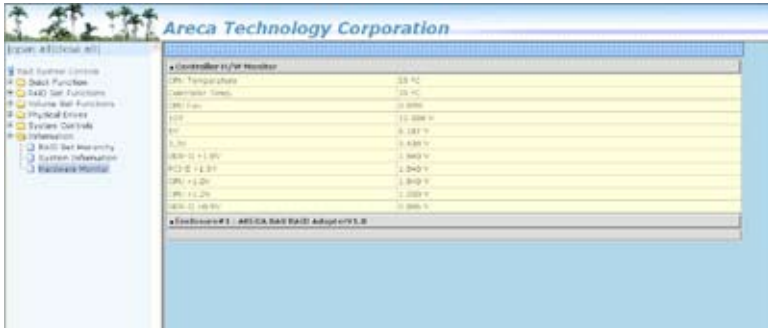

## Appendix A

### Upgrading Flash ROM Update Process

Since the PCIe SAS RAID controller features flash ROM firmware, it is not necessary to change the hardware flash chip in order to upgrade the RAID firmware. The user can simply re-program the old firmware through the In-Band PCIe bus or Out-of-Band Ethernet port McRAID Storage manager and nflash DOS utility. New releases of the firmware are available in the form of a DOS file on the shipped CD or Areca website. The files available at the FTP site for each model contain the following files in each version:

ARC1212NNNN.BIN Software Binary Code ( "NNNN" refers to the software code type)

ARC1212BIOS.BIN :→ PCI card BIOS for system board using

ARC1212BOOT.BIN :→ RAID controller hardware initialization

ARC1212FIRM.BIN :→ RAID kernel program

ARC1212MBR0.BIN:→ Master Boot Record for supporting Dual Flash Image in the SAS RAID controller

ARC1212transport.BIN: → Intel IOP 348 SAS controller transport layer microcode

README.TXT contains the history information of the software code change in the main directory. Read this file first to make sure you are upgrading to the proper binary file. Select the right file for the upgrade. Normally, user upgrades the ARC1212BIOS.BIN for system M/B compatibility and ARC1212FIRM.BIN for RAID function upgrades.

#### **Note:**

Please update all Binary Code (BIOS, BOOT and FIRM) before you reboot system. Otherwise, a mixed firmware package may hang the controller.



Controller with onboard LAN port, you can directly plug an Ethernet cable to the controller LAN port, then enter the McBIOS RAID manager to configure the network setting. After network setting configured and saved, you can find the current IP address in the McBIOS RAID manager "System Information" page.

From a remote pc, you can directly open a web browser and enter the IP address. Then enter user name and password to login and start your management. You can find the firmware update feature from the "Raid system Console" on the "System Controls" option.

## **Upgrading Firmware Through nflash DOS Utility**

Areca now offers an alternative means communication for the SAS RAID controller – Upgrade the all files (BIOS, BOOT, FIRM, MBR0 and Transport) without necessary system starting up to running the ArchHttp proxy server. The nflash utility program is a DOS application, which runs in the DOS operating system. Be sure of ensuring properly to communicate between SAS RAID controller and nflash DOS utility. Please make a bootable DOS floppy diskette or UBS devices from other Windows operating system and boot up the system from those bootable devices.

### **• Starting the nflash Utility**

You do not need to short any jumper cap on running nflash utility. The nflash utility provides an on-line table of contents, brief descriptions of the help sub-commands. The nflash utility put on the <CD-ROM>\Firmware directory. You can run the <nflash> to get more detailed information about the command usage. Typical output looks as below:

# APPENDIX

---

```
A:\nflash
Raid Controller Flash Utility
V1.11 2007-11-8
Command Usage:
NFLASH FileName
NFLASH FileName /cn --> n=0,1,2,3 write binary to controller#0
FileName May Be ARC1680FIRM.BIN or ARC1680*
For ARC1212* Will Expand To ARC1212BOOT /FIRM/BIOS.BIN

A:\>nflash arc1212~1.bin
Raid Controller Flash Utility
V1.11 2007-11-8
NODEL : ARC-1212
MEM FE620000 FE7FF000
File ARC121~1.BIN : >>*** => Flash OK
```

## Upgrading Firmware Through CLI

This Command Line Interface (CLI) provides you to configure and manage the Areca SAS RAID controller components in Windows, Linux, FreeBSD and more environments. The CLI is useful in environments where a graphical user interface (GUI) is not available. Through the CLI, you perform firmware upgrade that you can perform with the McRAID storage manager GUI. From firmware version 1.43 and CLI version 1.72.250 beginning, the controller has added the firmware update through the CLI on the controller.

To update the controller firmware, follow the procedure below:

```
Parameter:<path=<PATH_OF_FIRMWARE_FILE>>
Fn: Firmware Updating.
Ex: Update Firmware And File Path Is In [C:\FW\ARC1110FIRM.BIN.]
Command: sys updatefw path=c:\fw\arc1212firm.bin [Enter]
```

## Appendix B

### Battery Backup Module (ARC-6120-BAT-xxx)

The SAS RAID controller operates using cache memory. The Battery Backup Module is an add-on module that provides power to the SAS RAID controller cache memory in the event of a power failure. The BBM monitors the write back cache on the SAS RAID controller, and provides power to the cache memory if it contains data not yet written to the hard drives when power failure occurs.

#### BBM Components

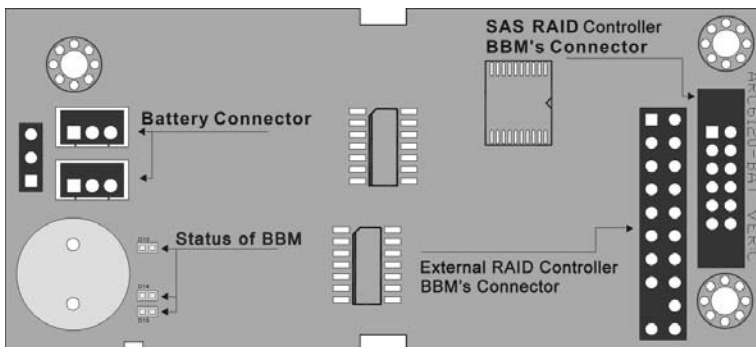

#### Status of BBM

- D13 (Green) : light when BBM activated
- D14 (Red) : light when BBM charging
- D15 (Green) : light when BBM normal

#### Installation

1. Make sure all power to the system is disconnected.
2. Connector J2 is available for the optional battery backup module. Connect the BBM cable to the 12-pin battery connector on the controller.

# APPENDIX

---

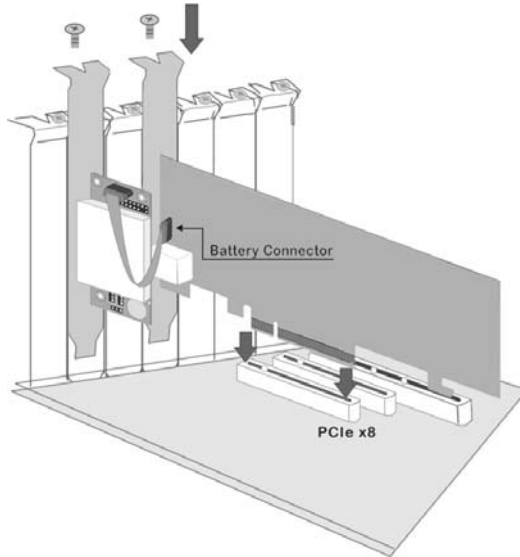

3. Integrators may provide pre-drilled holes in their cabinet for securing the BBM using its three mounting positions.
4. Low profile bracket also provided.

## Battery Backup Capacity

Battery backup capacity is defined as the maximum duration of a power failure for which data in the cache memory can be maintained by the battery. The BBM's backup capacity varied with the memory chips that installed on the SAS RAID controller.

## Operation

1. Battery conditioning is automatic. There are no manual procedures for battery conditioning or preconditioning to be performed by the user.
2. In order to make sure of all the capacity is available for your battery cells, allow the battery cell to be fully charged when installed for the first time. The first time charge of a battery cell takes about 24 hours to complete.

## Changing the Battery Backup Module

At some point, the LI-ION battery will no longer accept a charge properly. LI-ION battery life expectancy is anywhere from approximately 1 to 5 years.

1. Shutdown the operating system properly. Make sure that cache memory has been flushed.
2. Disconnect the BBM cable from J2 on the SAS RAID controller.
3. Disconnect the battery pack cable from JP2 on the BBM.
4. Install a new battery pack and connect the new battery pack to JP2.
5. Connect the BBBM to J2 on the SAS controller.
6. Disable the write-back function from the McBIOS RAID manager or McRAID storage manager .

### **Note:**

Do not remove BBM while system is running.

### **Battery Functionality Test Procedure:**

1. Writing amount of data into controller volume, about 5GB or bigger.
2. Waiting for few seconds, power failed system by remove the power cable
3. Check the battery status, make sure the D13 is bright light, and battery beeps every few seconds.
4. Power on system, and press Tab/F6 to login controller.
5. Check the controller event log, make sure the event shows controller boot up with power recovered.

## **BBM Specifications**

### Mechanical

- Module Dimension (W x H x D)  
37.3 x 13 x 81.6 mm
- BBM Connector  
2 \* 6 box header

### Environmental

- Operating Temperature

# APPENDIX

---

Temperature: -25° C to +75° C

- Humidity: 45-85%, non-condensing
- Storage Temperature  
Temperature: -40° C to 85° C
- Humidity: 45-85%, non-condensing

## Electrical

- Input Voltage  
+3.6VDC
- On Board Battery Capacity  
1100mAH (1\*1100mAH)

## Appendix C

### SNMP Operation & Installation

#### Overview

The McRAID storage manager includes a firmware-embedded Simple Network Management Protocol (SNMP) agent and SNMP Extension Agent for the SAS RAID controller. An SNMP-based management application (also known as an SNMP manager) can monitor the disk array. An example of An SNMP management application is Hewlett-Packard's Open View. The SNMP extension agent can be used to augment the SAS RAID controller if you are already running an SNMP management application at your site.

#### SNMP Definition

SNMP, an IP-based protocol, has a set of commands for getting the status of target devices. The SNMP management platform is called the SNMP manager, and the managed devices have the SNMP agent loaded. Management data is organized in a hierarchical data structure called the Management Information Base (MIB). These MIBs are defined and sanctioned by various industry associations. The objective is for all vendors to create products in compliance with these MIBs so that inter-vendor interoperability can be achieved. If a vendor wishes to include additional device information that is not specified in a standard MIB, then that is usually done through MIB extensions.

# APPENDIX

---

## MIB Compilation and Definition File Creation

Before the manager application accesses the RAID controller, it is necessary to integrate the MIB into the management application's database of events and status indicator codes. This process is known as compiling the MIB into the application. This process is highly vendor-specific and should be well-covered in the User's Guide of your SNMP application. Ensure the compilation process successfully integrates the contents of the ARECARAID.MIB file into the traps database.

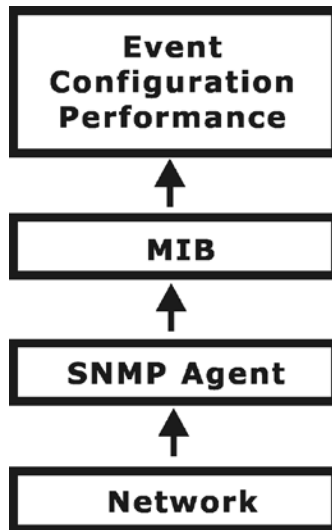

### SNMP Installation

The installation of the SNMP manager is accomplished in several phases:

- Starting the firmware-embedded SNMP community configuration.
- Installing the SNMP extension agent on the server
- Installing the SNMP manager software on the client
- Placing a copy of the Management Information Base (MIB) in a directory which is accessible to the management application
- Compiling the MIB description file with the management application

## Starting the SNMP Function Setting

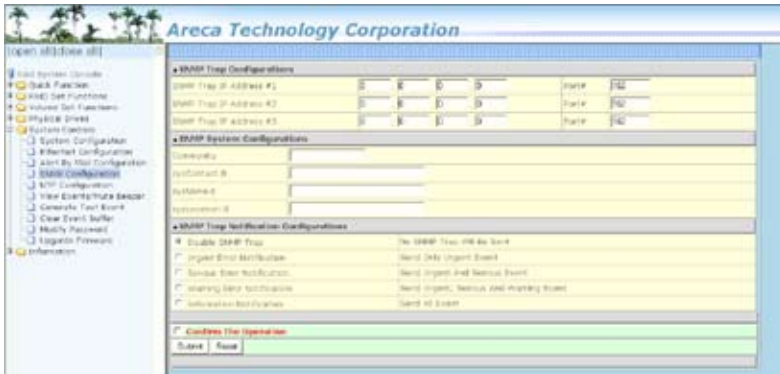

### • Community Name

Community name acts as a password to screen accesses to the SNMP agent of a particular network device. Type in the community names of the SNMP agent. Before access is granted to a request station, this station must incorporate a valid community name into its request; otherwise, the SNMP agent will deny access to the system.

Most network devices use "public" as default of their community names. This value is case-sensitive.

### SNMP Extension Agent Installation for Windows

You must have administrative level permission to install SAS RAID extension agent software. This procedure assumes that the SAS RAID hardware and Windows are both installed and operational in your system.

To enable the SNMP agent for Windows, configure Windows for TCP/IP and SNMP services. The Areca SNMP extension agent file is ARCSNMP.DLL.

Screen captures in this section are taken from a Windows XP installation. If you are running another version of Windows, your screens may look different, but the Areca SNMP extension agent installation is essentially the same.

1. Insert the RAID controller software CD in the CD-ROM drive.

# APPENDIX

---

2. Run the setup.exe file that resides at: <CD-ROM>\packages\windows\http\setup.exe on the CD. (If SNMP service was not installed, please install SNMP service first.)



3. Click on the "Setup.exe" file then the welcome screen appears.



4. Click the "Next" button and then the "Ready Install the Program" screen will appear. Follow the on-screen prompts to complete Areca SNMP extension agent installation.



5. A Progress bar appears that measures the progress of the Areca SNMP extension agent setup. When this screen completes, you have completed the Areca SNMP extension agent setup.



6. After a successful installation, the "Setup Complete" dialog box of the installation program is displayed. Click the "Finish" button to complete the installation.



## Starting SNMP Trap Notification Configurations

To start "SNMP Trap Notification Configurations", There have two methods. First, double-click on the "Areca RAID Controller".



Second, you may also use the "Taskbar Start/programs/Areca Technology Corp/ArcSnmpConf" menus shown below.

# APPENDIX

---

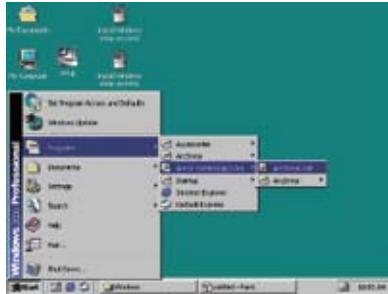

## SNMP Community Configurations

Please refer to the community name in this appendix.

## SNMP Trap Notification Configurations

The "Community Name" should be the same as firmware-embedded SNMP Community. The "SNMP Trap Notification Configurations" include level 1: Serious, level 2: Error, level 3: Warning and level 4: Information. The level 4 covers notification events such as initialization of the controller and initiation of the rebuilding process; Level 3 includes events which require the issuance of warning messages; Level 2 covers notification events which once have happen; Level 1 is the highest level, and covers events the need immediate attention (and action) from the administrator. (Please refer to Appendix E of Email Event Notification Configurations)



## SNMP Extension Agent Installation for Linux

You must have administrative level permission to install SAS RAID software. This procedure assumes that the SAS RAID hard-

ware and Linux are installed and operational in your system.

For the SNMP extension agent installation for Linux procedure, please refer to <CD-ROM>\packages\Linux\SNMP\Readme or download from [areca.com.tw](http://areca.com.tw)

## **SNMP Extension Agent Installation for FreeBSD**

You must have administrative level permission to install SAS RAID software. This procedure assumes that the SAS RAID hardware and FreeBSD are installed and operational in your system. For the SNMP extension agent installation for FreeBSD procedure please refer to <CD-ROM>\packages\FreeBSD\SNMP\Readme or download from <http://www.areca.com.tw>

# APPENDIX

## Appendix D

### Event Notification Configurations

The controller classifies disk array events into four levels depending on their severity. These include level 1: Urgent, level 2: Serious, level 3: Warning and level 4: Information. The level 4 covers notification events such as initialization of the controller and initiation of the rebuilding process; Level 2 covers notification events which once have happen; Level 3 includes events which require the issuance of warning messages; Level 1 is the highest level, and covers events the need immediate attention (and action) from the administrator. The following lists sample events for each level:

#### A. Device Event

Event	Level	Meaning	Action
Device Inserted	Warning	HDD inserted	
Device Removed	Warning	HDD removed	
Reading Error	Warning	HDD reading error	Keep Watching HDD status, may be it caused by noise or HDD unstable.
Writing Error	Warning	HDD writing error	Keep Watching HDD status, may be it caused by noise or HDD unstable.
ATA Ecc Error	Warning	HDD ECC error	Keep Watching HDD status, may be it caused by noise or HDD unstable.
Change ATA Mode	Warning	HDD change ATA mode	Check HDD connection
Time Out Error	Warning	HDD time out	Keep Watching HDD status, may be it caused by noise or HDD unstable.
Device Failed	Urgent	HDD failure	Replace HDD
PCI Parity Error	Serious	PCI parity error	If only happen once, it may be caused by noise. If always happen, please check power supply or contact to us.
Device Failed(SMART)	Urgent	HDD SMART failure	Replace HDD

PassThrough Disk Created	Inform	Pass Through Disk created	
PassThrough Disk Modified	Inform	Pass Through Disk modified	
PassThrough Disk Deleted	Inform	Pass Through Disk deleted	

## B. Volume Event

Event	Level	Meaning	Action
Start Initialize	Warning	Volume initialization has started	
Start Rebuilding	Warning	Volume rebuilding has started	
Start Migrating	Warning	Volume migration has started	
Start Checking	Warning	Volume parity checking has started	
Complete Init	Warning	Volume initialization completed	
Complete Rebuild	Warning	Volume rebuilding completed	
Complete Migrate	Warning	Volume migration completed	
Complete Check	Warning	Volume parity checking completed	
Create Volume	Warning	New volume created	
Delete Volume	Warning	Volume deleted	
Modify Volume	Warning	Volume modified	
Volume Degraded	Urgent	Volume degraded	Replace HDD
Volume Failed	Urgent	Volume failure	
Failed Volume Revived	Urgent	Failed volume revived	
Abort Initialization	Warning	Initialization been abort	
Abort Rebuilding	Warning	Rebuilding aborted	
Abort Migration	Warning	Migration aborted	
Abort Checking	Warning	Parity check aborted	
Stop Initialization	Warning	Initialization stopped	
Stop Rebuilding	Warning	Rebuilding stopped	
Stop Migration	Warning	Migration stopped	
Stop Checking	Warning	Parity check stopped	

# APPENDIX

## C. RAID Set Event

Event	Level	Meaning	Action
Create RaidSet	Warning	New RAID set created	
Delete RaidSet	Warning	Raidset deleted	
Expand RaidSet	Warning	Raidset expanded	
Rebuild RaidSet	Warning	Raidset rebuilding	
RaidSet Degraded	Urgent	Raidset degraded	Replace HDD

## D. Hardware Monitor Event

Event	Level	Meaning	Action
DRAM 1-Bit ECC	Urgent	DRAM 1-Bit ECC error	Check DRAM
DRAM Fatal Error	Urgent	DRAM fatal error encountered	Check the DRAM module and replace with new one if required.
Controller Over Temperature	Urgent	Abnormally high temperature detected on controller (over 60 degree)	Check air flow and cooling fan of the enclosure, and contact us.
Hdd Over Temperature	Urgent	Abnormally high temperature detected on Hdd (over 55 degree)	Check air flow and cooling fan of the enclosure.
Fan Failed	Urgent	Cooling Fan # failure or speed below 1700RPM	Check cooling fan of the enclosure and replace with a new one if required.
Controller Temp. Recovered	Serious	Controller temperature back to normal level	
Hdd Temp. Recovered			
Raid Powered On	Warning	RAID power on	
Test Event	Urgent	Test event	
Power On With Battery Backup	Warning	RAID power on with battery backup	
Incomplete RAID Discovered	Serious	Some RAID set member disks missing before power on	Check disk information to find out which channel missing.
HTTP Log In	Serious	a HTTP login detected	

# APPENDIX

Telnet Log	Serious	a Telnet login detected	
InVT100 Log In	Serious	a VT100 login detected	
API Log In	Serious	a API login detected	
Lost Rebuilding/ MigrationLBA	Urgent	Some rebuilding/ migration raidset member disks missing before power on.	Reinserted the missing member disk back, controller will continued the incompleted rebuilding/migration.

# APPENDIX

---

## Appendix E

### RAID Concept

#### RAID Set

A RAID set is a group of disks connected to a SAS RAID controller. A RAID set contains one or more volume sets. The RAID set itself does not define the RAID level (0, 1, 10, 3, 5, 6, 30, 50 60, etc); the RAID level is defined within each volume set. Therefore, volume sets are contained within RAID sets and RAID Level is defined within the volume set. If physical disks of different capacities are grouped together in a RAID set, then the capacity of the smallest disk will become the effective capacity of all the disks in the RAID set.

#### Volume Set

Each volume set is seen by the host system as a single logical device (in other words, a single large virtual hard disk). A volume set will use a specific RAID level, which will require one or more physical disks (depending on the RAID level used). RAID level refers to the level of performance and data protection of a volume set. The capacity of a volume set can consume all or a portion of the available disk capacity in a RAID set. Multiple volume sets can exist in a RAID set. For the SAS RAID controller, a volume set must be created either on an existing RAID set or on a group of available individual disks (disks that are about to become part of a RAID set). If there are pre-existing RAID sets with available capacity and enough disks for the desired RAID level, then the volume set can be created in the existing RAID set of the user's choice.

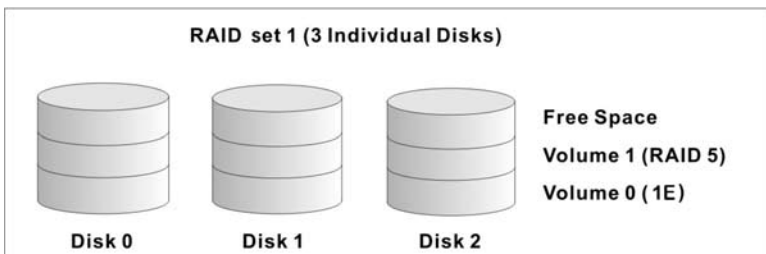

In the illustration, volume 1 can be assigned a RAID level 5 of operation while volume 0 might be assigned a RAID level 10 of operation. Alternatively, the free space can be used to create volume 2, which could then be set to use RAID level 5.

## Ease of Use Features

### • **Foreground Availability/Background Initialization**

RAID 0 and RAID 1 volume sets can be used immediately after creation because they do not create parity data. However, RAID 3, 5, 6, 30, 50 or 60 volume sets must be initialized to generate parity information. In Background Initialization, the initialization proceeds as a background task, and the volume set is fully accessible for system reads and writes. The operating system can instantly access the newly created arrays without requiring a reboot and without waiting for initialization to complete. Furthermore, the volume set is protected against disk failures while initialing. If using Foreground Initialization, the initialization process must be completed before the volume set is ready for system accesses.

### • **Online Array Roaming**

The SAS RAID controllers store RAID configuration information on the disk drives. The controller therefore protects the configuration settings in the event of controller failure. Online array roaming allows the administrators the ability to move a complete RAID set to another system without losing RAID configuration information or data on that RAID set. Therefore, if a server fails, the RAID set disk drives can be moved to another server with an Areca SAS/SATA RAID controllers and the disks can be inserted in any order.

### • **Online Capacity Expansion**

Online Capacity Expansion makes it possible to add one or more physical drives to a volume set without interrupting server operation, eliminating the need to backup and restore after reconfiguration of the RAID set. When disks are added to a RAID set, unused capacity is added to the end of the RAID set. Then, data

# APPENDIX

---

on the existing volume sets (residing on the newly expanded RAID set) is redistributed evenly across all the disks. A contiguous block of unused capacity is made available on the RAID set. The unused capacity can be used to create additional volume sets.

A disk, to be added to a RAID set, must be in normal mode (not failed), free (not spare, in a RAID set, or passed through to host) and must have at least the same capacity as the smallest disk capacity already in the RAID set.

Capacity expansion is only permitted to proceed if all volumes on the RAID set are in the normal status. During the expansion process, the volume sets being expanded can be accessed by the host system. In addition, the volume sets with RAID level 1, 10, 3, 5 or 6 are protected against data loss in the event of disk failure(s). In the case of disk failure, the volume set changes from "migrating" state to "migrating+degraded" state. When the expansion is completed, the volume set would then transition to "degraded" mode. If a global hot spare is present, then it further changes to the "rebuilding" state.

The expansion process is illustrated as following figure.

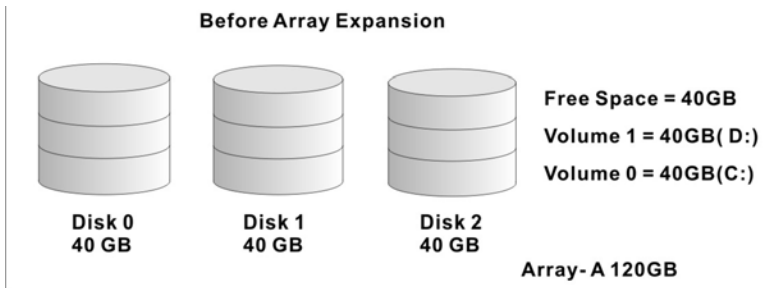

The SAS RAID controller redistributes the original volume set over the original and newly added disks, using the same fault-tolerance configuration. The unused capacity on the expand RAID set can then be used to create an additional volume set, with a different fault tolerance setting (if required by the user.)

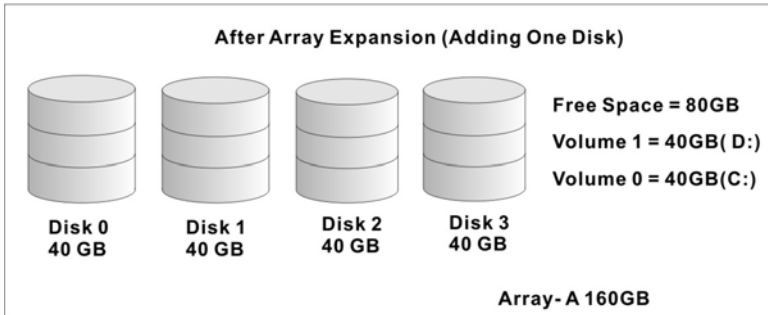

## ● Online RAID Level and Stripe Size Migration

For those who wish to later upgrade to any RAID capabilities, a system with Areca online RAID level/stripe size migration allows a simplified upgrade to any supported RAID level without having to reinstall the operating system.

The SAS RAID controllers can migrate both the RAID level and stripe size of an existing volume set, while the server is on-line and the volume set is in use. Online RAID level/stripe size migration can prove helpful during performance tuning activities as well as when additional physical disks are added to the SAS RAID controller. For example, in a system using two drives in RAID level 1, it is possible to add a single drive and add capacity and retain fault tolerance. (Normally, expanding a RAID level 1 array would require the addition of two disks). A third disk can be added to the existing RAID logical drive and the volume set can then be migrated from RAID level 1 to 5. The result would be parity fault tolerance and double the available capacity without taking the system down. A fourth disk could be added to migrate to RAID level 6. It is only possible to migrate to a higher RAID level by adding a disk; disks in an existing array can't be reconfigured for a higher RAID level without adding a disk. Online migration is only permitted to begin, if all volumes to be migrated are in the normal mode. During the migration process, the volume sets being migrated are accessed by the host system. In addition, the volume sets with RAID level 1, 10, 3, 5 or 6 are protected against data loss in the event of disk failure(s). In the case of disk failure, the volume set transitions from migrating state to (migrating+degraded) state. When the migra-

# APPENDIX

---

tion is completed, the volume set transitions to degraded mode. If a global hot spare is present, then it further transitions to rebuilding state.

## • **Online Volume Expansion**

Performing a volume expansion on the controller is the process of growing only the size of the latest volume. A more flexible option is for the array to concatenate an additional drive into the RAID set and then expand the volumes on the fly. This happens transparently while the volumes are online, but, at the end of the process, the operating system will detect free space at after the existing volume.

Windows, NetWare and other advanced operating systems support volume expansion, which enables you to incorporate the additional free space within the volume into the operating system partition. The operating system partition is extended to incorporate the free space so it can be used by the operating system without creating a new operating system partition.

You can use the Diskpart.exe command line utility, included with Windows Server 2003 or the Windows 2000 Resource Kit, to extend an existing partition into free space in the dynamic disk.

Third-party software vendors have created utilities that can be used to repartition disks without data loss. Most of these utilities work offline. Partition Magic is one such utility.

## **High availability**

### • **Global Hot Spares**

A Global Hot Spare is an unused online available drive, which is ready for replacing the failure disk. The Global Hot Spare is one of the most important features that SAS RAID controllers provide to deliver a high degree of fault-tolerance. A Global Hot Spare is a spare physical drive that has been marked as a global hot spare and therefore is not a member of any RAID set. If a disk drive used in a volume set fails, then the Global Hot Spare will

automatically take its place and the data previously located on the failed drive is reconstructed on the Global Hot Spare.

For this feature to work properly, the global hot spare must have at least the same capacity as the drive it replaces. Global Hot Spares only work with RAID level 1, 10, 3, 5, 6, 30, 50, or 60 volume set. You can configure up to three global hot spares with SAS RAID controller.

**Important:**

The hot spare must have at least the same capacity as the drive it replaces.

## ● **Hot-Swap Disk Drive Support**

The SAS RAID controller chip includes a protection circuit that supports the replacement of SAS/SATA hard disk drives without having to shut down or reboot the system. A removable hard drive tray can deliver “hot swappable” fault-tolerant RAID solutions. This feature provides advanced fault tolerant RAID protection and “online” drive replacement.

## ● **Auto Declare Hot-Spare**

If a disk drive is brought online into a system operating in degraded mode, the SAS RAID controllers will automatically declare the new disk as a spare and begin rebuilding the degraded volume. The Auto Declare Hot-Spare function requires that the smallest drive contained within the volume set in which the failure occurred.

In the normal status, the newly installed drive will be reconfigured an online free disk. But, the newly-installed drive is automatically assigned as a hot spare if any hot spare disk was used to rebuild and without new installed drive replaced it. In this condition, the Auto Declare Hot-Spare status will be disappeared if the RAID subsystem has since powered off/on.

# APPENDIX

---

The Hot-Swap function can be used to rebuild disk drives in arrays with data redundancy such as RAID level 1, 10, 3, 5, 6, 30, 50 and 60.

## • Auto Rebuilding

If a hot spare is available, the rebuild starts automatically when a drive fails. The SAS RAID controllers automatically and transparently rebuild failed drives in the background at user-definable rebuild rates.

If a hot spare is not available, the failed disk drive must be replaced with a new disk drive so that the data on the failed drive can be automatically rebuilt and so that fault tolerance can be maintained.

The SAS RAID controllers will automatically restart the system and rebuilding process if the system is shut down or powered off abnormally during a reconstruction procedure condition.

When a disk is hot swapped, although the system is functionally operational, the system may no longer be fault tolerant. Fault tolerance will be lost until the removed drive is replaced and the rebuild operation is completed.

During the automatic rebuild process, system activity will continue as normal, however, the system performance and fault tolerance will be affected.

## • Adjustable Rebuild Priority

Rebuilding a degraded volume incurs a load on the RAID subsystem. The SAS RAID controllers allow the user to select the rebuild priority to balance volume access and rebuild tasks appropriately. The Background Task Priority is a relative indication of how much time the controller devotes to a background operation, such as rebuilding or migrating.

The SAS RAID controller allows user to choose the task priority (Ultra Low (5%), Low (20%), Medium (50%), High (80%)) to balance volume set access and background tasks appropriately. For

high array performance, specify an Ultra Low value. Like volume initialization, after a volume rebuilds, it does not require a system reboot.

## High Reliability

### • Hard Drive Failure Prediction

In an effort to help users avoid data loss, disk manufacturers are now incorporating logic into their drives that acts as an "early warning system" for pending drive problems. This system is called SMART. The disk integrated controller works with multiple sensors to monitor various aspects of the drive's performance, determines from this information if the drive is behaving normally or not, and makes available status information to SAS RAID controller firmware that probes the drive and look at it.

The SMART can often predict a problem before failure occurs. The controllers will recognize a SMART error code and notify the administer of an impending hard drive failure.

### • Auto Reassign Sector

Under normal operation, even initially defect-free drive media can develop defects. This is a common phenomenon. The bit density and rotational speed of disks is increasing every year, and so are the potential of problems. Usually a drive can internally remap bad sectors without external help using cyclic redundancy check (CRC) checksums stored at the end of each sector.

SAS RAID controller drives perform automatic defect re-assignment for both read and write errors. Writes are always completed - if a location to be written is found to be defective, the drive will automatically relocate that write command to a new location and map out the defective location. If there is a recoverable read error, the correct data will be transferred to the host and that location will be tested by the drive to be certain the location is not defective. If it is found to have a defect, data will be automatically relocated, and the defective location is mapped out to prevent future write attempts.

# APPENDIX

---

In the event of an unrecoverable read error, the error will be reported to the host and the location will be flagged as being potentially defective. A subsequent write to that location will initiate a sector test and relocation should that location prove to have a defect. Auto Reassign Sector does not affect disk subsystem performance because it runs as a background task. Auto Reassign Sector discontinues when the operating system makes a request.

## ● Consistency Check

A consistency check is a process that verifies the integrity of redundant data. To verify RAID 3, 5, 6, 30, 50 or 60 redundancy, a consistency check reads all associated data blocks, computes parity, reads parity, and verifies that the computed parity matches the read parity.

Consistency checks are very important because they detect and correct parity errors or bad disk blocks in the drive. A consistency check forces every block on a volume to be read, and any bad blocks are marked; those blocks are not used again. This is critical and important because a bad disk block can prevent a disk rebuild from completing. We strongly recommend that you run consistency checks on a regular basis—at least once per week. Note that consistency checks degrade performance, so you should run them when the system load can tolerate it.

## Data Protection

### ● Battery Backup

The SAS RAID controllers are armed with a Battery Backup Module (BBM). While a Uninterruptible Power Supply (UPS) protects most servers from power fluctuations or failures, a BBM provides an additional level of protection. In the event of a power failure, a BBM supplies power to retain data in the SAS RAID controller's cache, thereby permitting any potentially dirty data in the cache to be flushed out to secondary storage when power is restored.

The batteries in the BBM are recharged continuously through a trickle-charging process whenever the system power is on. The

batteries protect data in a failed server for up to three or four days, depending on the size of the memory module. Under normal operating conditions, the batteries last for three years before replacement is necessary.

- **Recovery ROM**

The SAS RAID controller firmware is stored on the flash ROM and is executed by the I/O processor. The firmware can also be updated through the SAS RAID controllers PCIe bus port or Ethernet port without the need to replace any hardware chips. During the controller firmware upgrade flash process, it is possible for a problem to occur resulting in corruption of the controller firmware. With our Redundant Flash Image feature, the controller will revert back to the last known version of firmware and continue operating. This reduces the risk of system failure due to firmware crash.

# APPENDIX

---

## Appendix F

### Understanding RAID

RAID is an acronym for Redundant Array of Independent Disks. It is an array of multiple independent hard disk drives that provides high performance and fault tolerance. The SAS RAID controller implements several levels of the Berkeley RAID technology. An appropriate RAID level is selected when the volume sets are defined or created. This decision should be based on the desired disk capacity, data availability (fault tolerance or redundancy), and disk performance. The following section discusses the RAID levels supported by the SAS RAID controllers.

The SAS RAID controllers makes the RAID implementation and the disks' physical configuration transparent to the host operating system. This means that the host operating system drivers and software utilities are not affected, regardless of the RAID level selected. Correct installation of the disk array and the controller requires a proper understanding of RAID technology and the concepts.

#### RAID 0

RAID 0, also referred to as striping, writes stripes of data across multiple disk drives instead of just one disk drive. RAID 0 does not provide any data redundancy, but does offer the best High-speed data throughput. RAID 0 breaks up data into smaller blocks and then writes a block to each drive in the array. Disk striping enhances performance because multiple drives are accessed simultaneously; the reliability of RAID level 0 is less because the entire array will fail if any one disk drive fails.

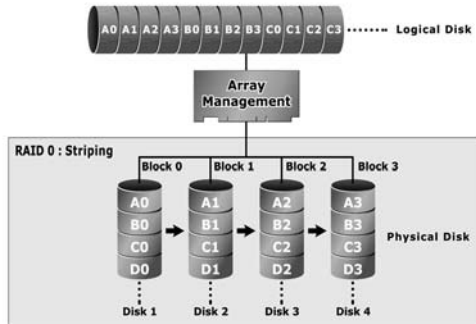

## RAID 1

RAID 1 is also known as “disk mirroring”; data written on one disk drive is simultaneously written to another disk drive. Read performance will be enhanced if the array controller can, in parallel, access both members of a mirrored pair. During writes, there will be a minor performance penalty when compared to writing to a single disk. If one drive fails, all data (and software applications) are preserved on the other drive. RAID 1 offers extremely high data reliability, but at the cost of doubling the required data storage capacity.

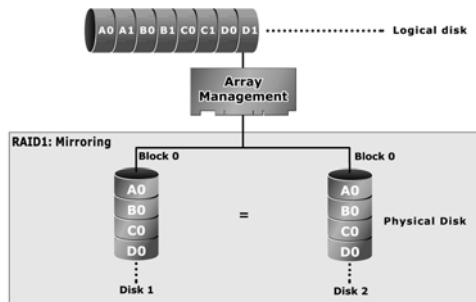

# APPENDIX

---

## RAID 10

RAID 10 is a combination of RAID 0 and RAID 1, combining striping with disk mirroring. RAID Level 10 combines the fast performance of Level 0 with the data redundancy of level 1. In this configuration, data is distributed across several disk drives, similar to Level 0, which are then duplicated to another set of drive for data protection. RAID 10 has been traditionally implemented using an even number of disks, some hybrids can use an odd number of disks as well. Illustration is an example of a hybrid RAID 10 array comprised of five disks; A, B, C, D and E. In this configuration, each strip is mirrored on an adjacent disk with wrap-around. Areca RAID 10 offers a little more flexibility in choosing the number of disks that can be used to constitute an array. The number can be even or odd.

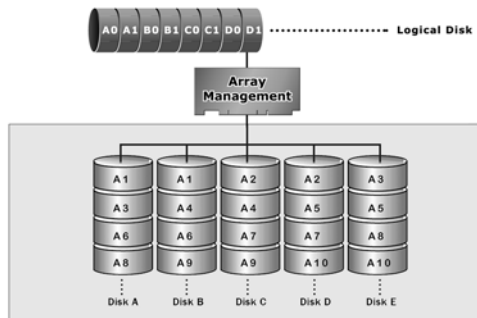

## RAID 3

RAID 3 provides disk striping and complete data redundancy through a dedicated parity drive. RAID 3 breaks up data into smaller blocks, calculates parity by performing an exclusive-or on the blocks, and then writes the blocks to all but one drive in the array. The parity data created during the exclusive-or is then written to the last drive in the array. If a single drive fails, data is still available by computing the exclusive-or of the contents corresponding strips of the surviving member disk. RAID 3 is best for applications that require very fast data-transfer rates or long data blocks.

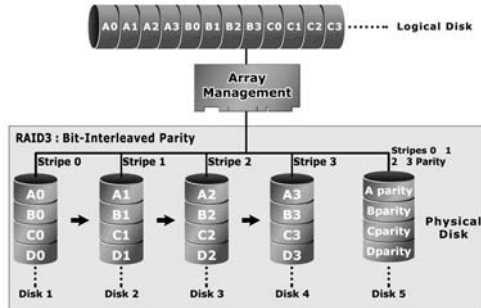

## RAID 5

RAID 5 is sometimes called striping with parity at byte level. In RAID 5, the parity information is written to all of the drives in the controllers rather than being concentrated on a dedicated parity disk. If one drive in the system fails, the parity information can be used to reconstruct the data from that drive. All drives in the array system can be used for seek operations at the same time, greatly increasing the performance of the RAID system. This relieves the write bottleneck that characterizes RAID 4, and is the primary reason that RAID 5 is more often implemented in RAID arrays.

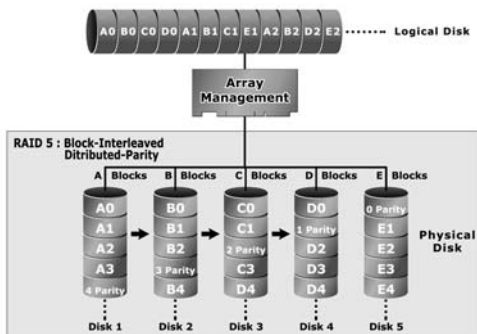

# APPENDIX

## RAID 6

RAID 6 provides the highest reliability. It is similar to RAID 5, but it performs two different parity computations or the same computation on overlapping subsets of the data. RAID 6 can offer fault tolerance greater than RAID 1 or RAID 5 but only consumes the capacity of 2 disk drives for distributed parity data. RAID 6 is an extension of RAID 5 but uses a second, independent distributed parity scheme. Data is striped on a block level across a set of drives, and then a second set of parity is calculated and written across all of the drives.

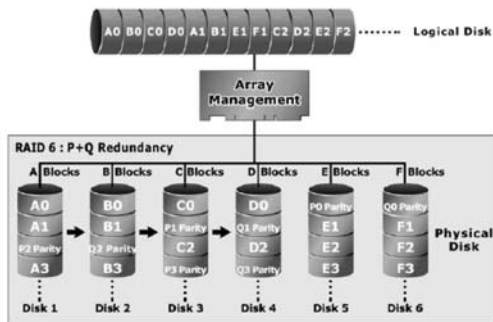

## RAID x0

RAID level-x0 refers to RAID level 30, 50 and 60. RAID x0 is a combination multiple RAID x volume sets with RAID 0 (striping). Striping helps to increase capacity and performance without adding disks to each RAID x array. The operating system uses the spanned volume in the same way as a regular volume. Up to one drive in each sub-volume (RAID 3 or 5) may fail without loss of data. Up to two drives in each sub-volume (RAID 6) may fail without loss of data.

RAID level x0 allows more physical drives in an array. The benefits of doing so are larger volume sets, increased performance, and increased reliability.

The following illustration is an example of a RAID level x0 logical drive.

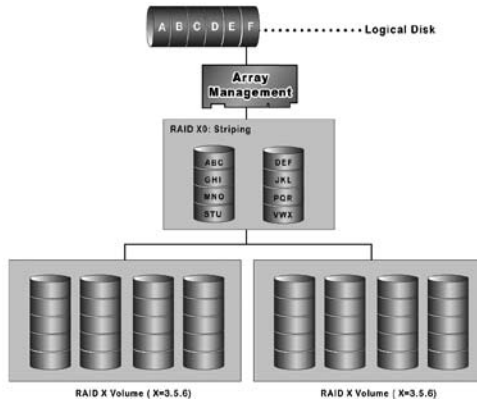

## **Important:**

RAID level 30, 50 and 60 can support up to eight sub-Volumes (RAID set). If the volume is RAID level 30, 50, or 60, you cannot change the volume to another RAID level. If the volume is RAID level 0, 1, 10, 3, 5, or 6, you cannot change the volume to RAID level 30, 50, or 60.

## **JBOD**

(Just a Bunch Of Disks) A group of hard disks in a RAID box are not set up as any type of RAID configuration. All drives are available to the operating system as an individual disk. JBOD does not provide data redundancy.

## **Single Disk (Pass-Through Disk)**

Pass through disk refers to a drive that is not controlled by the RAID firmware and thus can not be a part of a RAID volume. The drive is available to the operating system as an individual disk.

# APPENDIX

## Summary of RAID Levels

RAID subsystem supports RAID Level 0, 1, 10, 3, 5, 6, 30, 50 and 60. The following table provides a summary of RAID levels.

Features and Performance			
RAID Level	Description	Min. Disks requirement	Data Reliability
0	Also known as striping Data distributed across multiple drives in the array. There is no data protection.	1	No data Protection
1	Also known as mirroring All data replicated on N Separated disks. N is almost always 2. This is a high availability Solution, but due to the 100% duplication, it is also a costly solution.	2	Single-disk failure
10	Also known Block-Interleaved Parity. Data and parity information is subdivided and distributed across all disks. Parity must be the equal to the smallest disk capacity in the array. Parity information normally stored on a dedicated parity disk.	3	Single-disk failure
3	Also known Bit-Interleaved Parity. Data and parity information is subdivided and distributed across all disk. Parity must be the equal to the smallest disk capacity in the array. Parity information normally stored on a dedicated parity disk.	3	single-disk failure
5	Also known Block-Interleaved Distributed Parity. Data and parity information is subdivided and distributed across all disk. Parity must be the equal to the smallest disk capacity in the array. Parity information normally stored on a dedicated parity disk.	3	single-disk failure

# APPENDIX

6	As RAID level 5, but with additional independently computed redundant information	4	Two-disk failure
30	RAID 30 is a combination multiple RAID 3 volume sets with RAID 0 (striping)	6	Up to one disk failure in each sub-volume
50	RAID 50 is a combination multiple RAID 5 volume sets with RAID 0 (striping)	6	Up to one disk failure in each sub-volume
60	RAID 60 is a combination multiple RAID 6 volume sets with RAID 0 (striping)	8	Up to two disk failure in each sub-volume

# HISTORY

---

---

## Version History

Revision	Page	Description
1.0	p.133	Deleted note description